



protective

GROUP

AUSTRALIAN OWNED AND MANUFACTURED

- WELDED WIRE STEEL MESH
- WIRE MESH FENCING
- CHAINWIRE MESH
- HIGH SECURITY FENCING
- STEEL FABRICATION
- POWDER COATING

October

2018

CATALOGUE

CALL

02 4343 6200

sales@profence.com.au

www.profence.com.au

POWDER COATING

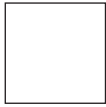

Standard Powdercoating Specifications
Pipe, Tube, Fittings, Panels & Gates



Standard Chainwire Gates

- 6.1 Domestic Gates - 900~1200mm High
- 6.2 Round Top Gates - 1500~1800mm High
- 6.3 Security Gates - 1800mm, 2100mm High

HIGH SECURITY FENCING



- 1.2 Traditional Palisade Fencing
- 1.4 Promax High Security Mesh Fencing

WIRE PRODUCTS & ACCESSORIES



- 7.1 Cable Wire & Tie Wire
- 7.1 Barbed & Razor Wire
- 7.2 Wire Rope, Straightened & Cut Wire
- 7.2 Security & Bag Ties
- 7.3 Wire Fastening Rings and Tools

MESH PLUS



- 2.1 High Security Welded Wire Mesh Sheets
- 2.2 General Purpose Mesh Sheets,
- 2.2 Pig Flooring Mesh
- 2.3 Farm Yard Mesh
- 2.3 Stainless Steel Mesh
- 2.3 Safety Roof Mesh
- 2.4 Welded Wire Mesh Rolls

FENCE & GATE FITTINGS



- 8.1 High Security Fence Fittings & Accessories
- 8.1 Fasteners
- 8.3 Uni-Fit Chainwire Fencing & Railing System
- 8.5 Fence Clamps
- 8.7 Hinges
- 8.8 Caps, Brackets & Joiners
- 8.8 Temporary Fence Clamps
- 8.9 Catches, Latches & Drop Bolts

PROFENCE STEELMESH FENCING



- 3.1 Banksia (Boronia) Fencing
- 3.2 Garden Fencing
- 3.3 Boulevard (Acacia, Classic) Fencing
- 3.4 Boulevard Security Fencing
- 3.5 Pool (Wattle) Fencing
- 3.6 Esplanade (Willow) Fencing

RURAL GUARD



- 9.1 Farm Yard Mesh & Pig Floor Mesh

CHAINWIRE FENCING

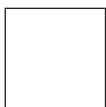

Diamond Fence Chainwire

- 4.1 Chainwire Specifications
- 4.1 60mm Mesh Rolls
- 4.2 50mm Mesh Rolls
- 4.5 49mm Mesh Rolls
- 4.5 45mm Mesh Rolls
- 4.6 40mm Mesh Rolls
- 4.7 30mm Mesh Rolls
- 4.7 25mm Mesh Rolls

SECURITY TUBULAR FENCING



- 10.1 Steel Panels & Posts, Rails & Pickets
- 10.3 Aluminium Panels & Posts

RMS PEDESTRIAN FENCING



- 11.1 Type 1 & Type 2 RMS Fencing

TERMS & CONDITIONS



Chainwire Fence Posts & Stays

- 5.1 Pipe - Stock Lengths
- 5.3 Security Fencing
- 5.4 Domestic Fencing
- 5.5 Tennis Court Fencing

POWDERCOATING

Standard Powdercoat Specifications

Steel fencing components supplied by Protective Fencing are powder coated in accordance with:- AS/NZS 4506-2005 Metal Finishing - Thermoset Powder Coatings

All galvanised components are pre-treated to ensure film adhesion. Components are coated using Interpon D1000 Excel™ powder developed for applications over porous substrates such as hot dip galvanised steel. Finished product is tested and recorded as per AS/NZS 4506-2005 for coating thickness, cure and adhesion.

Properly handled, installed and maintained powder coating will provide a long lasting decorative and durable surface coating. Regular maintenance is critical to ensure ongoing service life. Refer Promax Security Fencing document "Galvanised & Powder Coated Fencing Care & Maintenance" and AS/NZS 4506-2005 Appendix D.

Repairs to powder coating require the damaged surface to be rendered clean and sound prior to applying a compatible organic coating. Refer Interpon document "Repairs to Powder Coating".

Refer to profence.com.au for details of Warranties and Care and Maintenance.

Pipe - Standard Colours

SIZE	PRICE / M
20NB	
25NB	
32NB	
40NB	
50NB	
80NB	
100NB	
125NB	
150NB	

Tube - Standard Colours

SIZE	PRICE / M
25 x 25mm	
30 x 30mm	
35 x 35mm	
40 x 40mm	
50 x 20mm	
50 x 25mm	
50 x 50mm	
60 x 60mm	
65 x 35mm	
65 x 65mm	
75 x 25mm	
75 x 50mm	
75 x 75mm	
100 x 50mm	
100 x 100mm	
125 x 75mm	
150 x 50mm	

Standard Colours

(Also Known As)

- Black Satin (Night Sky)
- Monument
- Heritage Green
- Primrose (Domain)
- Deep Ocean (Mountain Blue, Bluestone)
- Pearl White
- Pale Eucalypt (Mist Green, Meadow)
- Woodland Grey (Slate Grey, Ridge Grey)
- Willow (Bond Rivergum, Wilderness)
- Manor Red (Heritage Red, Red Oak)
- Safety Yellow

Fence & Gate Fittings

TYPE	PRICE / EA
PIPE CLAMP FITTINGS	
PANEL BRACKETS	

Mesh/Panels & Gates

TYPE	PRICE / SQ M
PANELS / GATES	
GATES OVER 200KG	
GP MESH 2.4M X 3M	

High Security Mesh

TYPE	PRICE / SQ M
358, 258 & EA MESH	

OTHER INTERPON COLOURS AVAILABLE POA

MEMBER



AUSTRALIAN STEEL INSTITUTE

AiGROUP

AUSTRALIAN INDUSTRY GROUP



AUSTRALIAN SECURITY INDUSTRY ASSOCIATION LIMITED

www.profence.com.au

HIGH SECURITY FENCING SYSTEMS



Protecting the Future Through Innovation

TRADITIONAL PALISADE FENCING



Promax Traditional Palisade System

Protective manufacture and supply palisade fence materials based on traditional specifications using pencil point TFB posts and 150UB 14.0 posts and standard 50x50x6 rails. All W pales are of a BS1722-12 approved design and comply with all the strength requirements specified in Annex A & C. Rail positions have been standardised and positioned for greatest security for 2 and 3 rail fences. Other rail positions can be supplied to match existing installations. Pale centres are standardised at 155mm as per BS1722-12. Other specified centres are available upon request.

Protective are happy to advise, schedule material quantities and estimate cost on a project by project basis.

A powdercoating service is available from Protective's in house powdercoating plant. Protective is an approved applicator of Interpon D1000 powder over porous substrates such as hot dip galvanised steel.

SPECIFICATIONS

- Post - Pencil point: 2400 High fence - 100x45 TFB
- 3000 High Fence - 150 UB 14.0
- Rail: 50x50x6 EA
- Fish Plate: 40x8 140 long
- Corner Fish Plate: 40x8 215 long W Profile
- W Pale: 71x21x3 W Profile
- Rail Fixings: M12x30 Cuphead Bolt and Shear Nut
- Pale Fixings: M8x25 T Bolt and Shear Nut
or - Stainless Steel Huck Pin and Collar
- Mid Bay Support: M12x500 thread Rod and Nuts
Only required for fences over 2400 high.

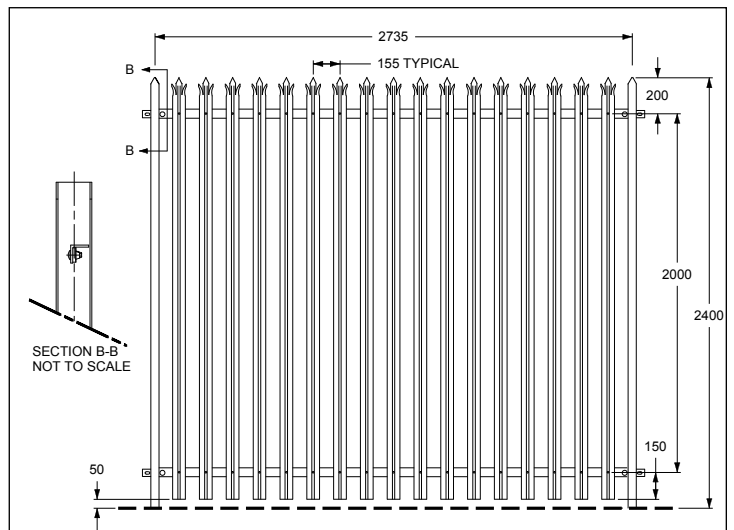

STANDARD 2400 HIGH TRI POINT STRAIGHT PALISADE PANEL

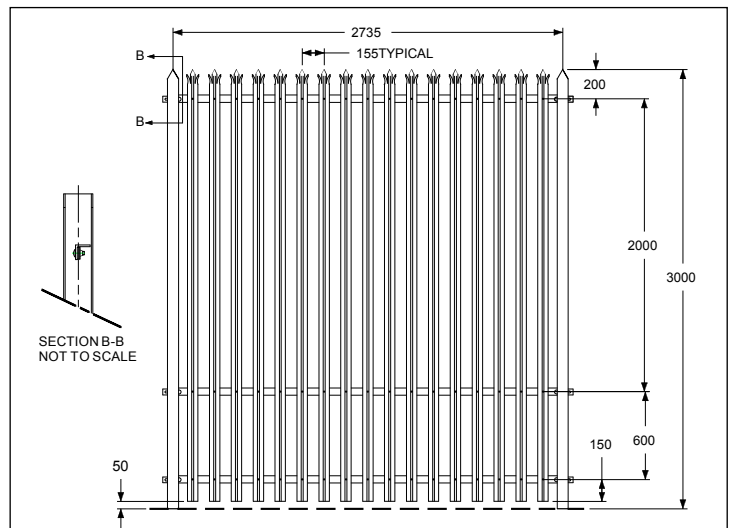

STANDARD 3000 HIGH TRI POINT STRAIGHT PALISADE FENCE

TRADITIONAL PALISADE FENCING

Posts - Hot Dip Galvanised

CODE	FENCE HEIGHT	POST	RAILS	LENGTH	WEIGHT
PP TFB 3300 G	2400	TFB 100x45	2	3300	25.7Kg
PP UB150 4000 G	3000	150UB 14.0	3	4000	60.1Kg

- Posts to suit other height fences with different embedment lengths or baseplated, available upon request.
- Earth tag plates optional

Rails - Hot Dip Galvanised

CODE	SIZE	LENGTH	PALE CENTRES	WEIGHT
PP REA502705G	50X50X6 EA	2705	155	13.0Kg

- Rails available to suit specific specifications also available upon request.
- All rails include hole for Mid Bay Support - Earth holes if required optional.

Pales - W Section - Hot Dip Galvanised

CODE	FENCE HEIGHT	TYPE	TOP	LENGTH	WEIGHT
PP PALE 2400 G	2400	STRAIGHT	TRI POINT	2350	5.64Kg
PP PALE 2950 HDG	3000	STRAIGHT	TRI POINT	2950	7.07Kg
PP PALE 2950 CG	3000	CURVED	TRI POINT	2950	7.28Kg

- Pales to suit other height fences or special rails centres available upon request.

Fittings & Accessories - Hot Dip Galvanised

CODE	DESCRIPTION	WEIGHT
FISHPLATES		
PP FP G	INTERMEDIATE FISH PLATE - 140x40x8 - 2 SLOTS	0.38Kg
PP EFP G	END FISH PLATE - 80x40x8 - 1 SLOT	0.38Kg
PP CFP	CORNER FISH PLATE - W SHAPE - 215x40x8 - 2 SLOTS	0.50Kg

MID BAY SUPPORT - REQUIRED ON ALL FENCES OVER 2400 HIGH

DCRM12500H	M12X500 THREADED ROD + 2 x M12 NUTS	0.85Kg
------------	-------------------------------------	--------

FASTENERS - ALL FASTENERS SUPPLIED IN PACKS OF 100 ONLY

PP M12 30 HTG	RAIL FIXING - M12X30 CUPHEAD BOLT - 8.8 HI TENSILE	4.35Kg/100
PSNM12G	RAIL FIXING - M12 SHEAR NUT	2.7Kg/100
DWG12MM	RAIL FIXING - M12 WASHER	0.63Kg/100
PP TB825G	PALE FIXING - M8X25 T BOLT	1.15Kg/100
PSNM8G	PALE FIXING - M8 SHEAR NUT	1.3Kg/100
PSSPIN	PALE FIXING - SS HUCK PIN	2.23Kg/100
PP SSSFCOLL	PALE FIXING - SS COLLAR	0.67Kg/100

Gates - Hot Dip Galvanised

- Standard sizes include - 1.2M PA, 4.8M double gate, 6M double gate.
- Gates to match fence height and customer specifications are manufactured to suit and priced accordingly.
- Additional lead times will apply to non standard gates
- Single PA gates are made as a post, gate and lock assembly and installed as one unit.
- Double gates are supplied with posts, gates, hinges and locks.

PROMAX HIGH SECURITY MESH FENCING



**PROTECTING THE FUTURE
THROUGH INNOVATION**

THE PROMAX SECURITY MESH FENCING SYSTEM

The Promax™ Mesh Fencing System has been developed to enhance the industry accepted 358 mesh market with new innovative perimeter posts, mesh, toppings and gates.

Protective Fencing is a leading Australian manufacturer of closed spaced security mesh with Promax™ 358 mesh (71 x 9mm aperture) as it's signature product.

Promax™ close spaced steel mesh provides maximum security by being extremely difficult to climb or penetrate using normal hand tools and yet has a minimal visual impact on the surrounds and an important clear line of horizontal sight.

Promax™ Security fencing utilizes the unique design registered Promax™ 'T' Post, a high strength medium weight post designed to combine better aesthetics with faster installation and less potential maintenance. All Promax™ mesh systems can be specified using either post and rail systems or successfully utilized as rail-less structures depending on the end use security level requirements.

The Promax™ 'T' post is designed to incorporate the use of the SMRTrail™ cable management system, an Australian first for mesh type security fencing. The Promax 'T' post has been engineered to accept anti ram cables and SMRTrail™ cable management without reducing the structural integrity of the fence. Promax™ 'T' Post 358 Mesh Fencing System has been engineered and certified for high security fencing up to 4.8M. For fencing over 4.8M or with a wind restrictive topping, other super T posts configurations are available.

- Unique engineered 'T' post - high strength medium weight.
- Design Registered.
- Easier faster installation - clear access for mesh attachment.
- Flat web for more versatile attachment of topping extensions etc.
- Curved corner option for improved aesthetics and reduced climb-ability.
- Optional rail-less fencing for reduced material and installation costs.
- High security yet low cost, low visual impact all in one PA gate system.
- Innovative topping extensions.
- Adaptable to all forms of mesh, expanded metal or perforated sheet.
- One piece 90° corner construction.
- Above ground cable management feature conforming to AS 3000.
- High security yet low cost, low visual impact all in one PA gate system.



OPTIONAL TAPERED BLADE BARBED WIRE EXTENSION



BULLDOG RAZOR TOPPING



TOP RAIL WITH CONCERTINA RAZOR TAPE ATTACHMENT

PROMAX HIGH SECURITY MESH FENCING

TYPICAL 2.4M HIGH 358 MESH FENCE
INGROUND OR BASE PLATED

COMPONENT LIST - PER PANEL SET

DESCRIPTION	QUANTITY
T POST - 100x6mm~125x6mm BULB FLAT x CONTINUOUS WELD 10X30mm SLOTS - HDG	2
RAIL - 50x50x4mm EQUAL ANGLE - 10X30mm SLOTS- HDG	2
PROMAX 358 MESH - 75x13mm WIRE CENTRES - ZALCOTE FINISH	1

FASTENERS

MESH/RAIL TO POST - M8X30mm CUPHEAD BOLT, MESH CLIP & SHEAR NUT - GAL	40
---	----

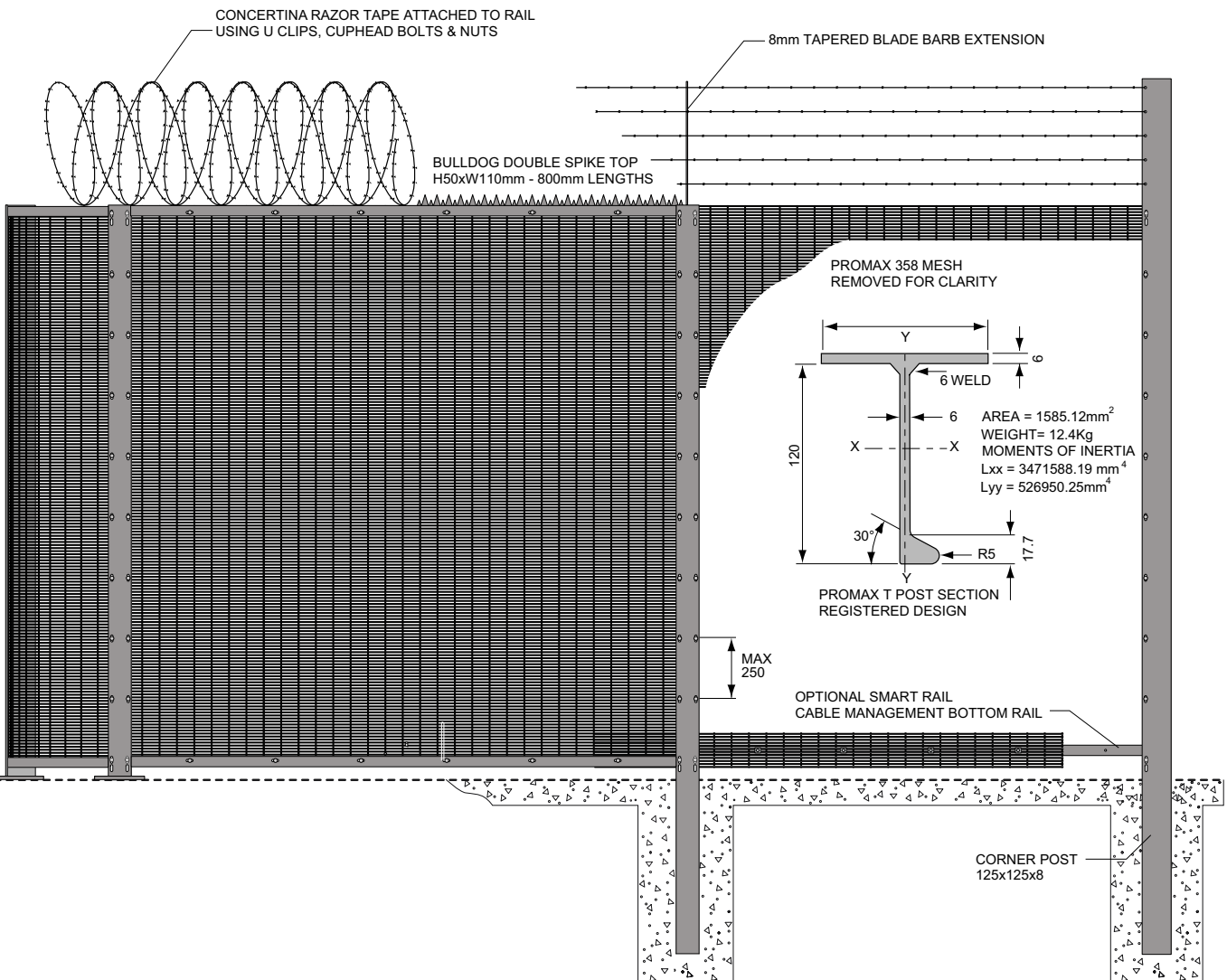
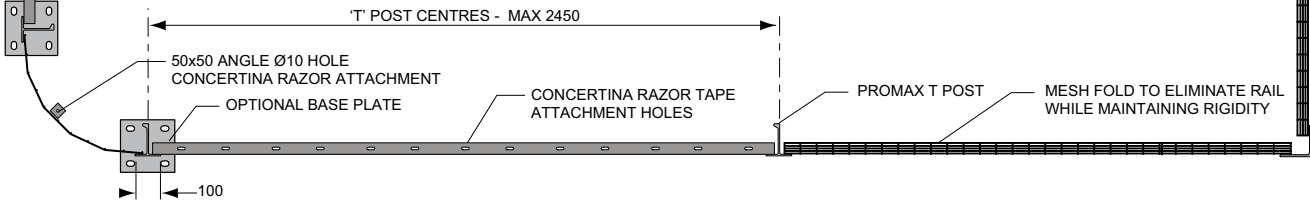
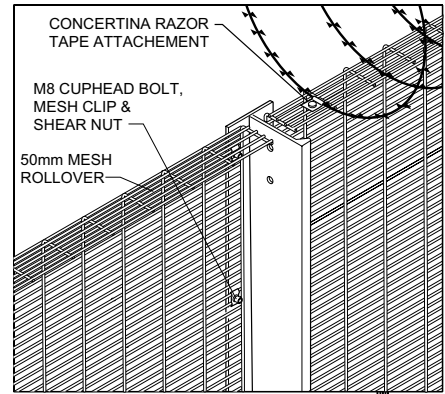

PROMAX MESH FENCING

Posts - Hot Dip Galvanised

CODE	NOMINAL HEIGHT	STD LENGTH	EMBEDMENT	SLOTS	WEIGHT
T POST - 100x120x6 - INGROUND - 14SQ EXTENSION & EARTH HOLES INCLUDED - 8.82Kg/M HDG					
PP T100 3400 G	2400	3400	925	235	45.2Kg
PP T100 4500 G	3000	4500	1425	246	59.4Kg

Other sizes to suit non standard fence heights are made to order.

Flanged posts available - 250x250x16mm plates standard or to Engineers requirements.

CORNER POST - STANDARD 125X125X8 EA - EARTH TAG INCLUDED - 16Kg/M HDG

PP CP 3400 G	2400	3400	NA	235	54.40Kg
PP CP 4500 G	3000	4500	NA	246	72.41Kg

Other sizes to suit non standard fence heights are made to order.

Flanged posts available - 250x250x16mm plates standard or to Engineers requirements.

Security Mesh - Zalcote

CODE	WIDTH	HEIGHT	LONG WIRE	CROSS WIRE	PITCH	WEIGHT
PROMAX 358 VARIMESH - 30, 50, 70 VARI PITCH ONE END - SUIT POST CENTRES 2440						
PMZ3582424	2404	2396	Ø4	Ø4	75X13	51.6Kg
PMZ35824255	2404	2550	Ø4	Ø4	75X13	54.0Kg
PMZ3582427	2404	2695	Ø4	Ø4	75X13	58.5Kg
PMZ3582430	2404	2994	Ø4	Ø4	75X13	64.9Kg
PMZ3582432	2404	3202	Ø4	Ø4	75X13	70.5Kg
PMZ3582436	2404	3592	Ø4	Ø4	75X13	75.7Kg
PMZ3582440	2404	3995	Ø4	Ø4	75X13	84.7Kg
PMZ3582445	2404	4502	Ø4	Ø4	75X13	95.3Kg
PMZ3582450	2404	4996	Ø4	Ø4	75X13	105.9Kg

PROMAX 258 VARIMESH - SUIT POST CENTRES 2440

PMZ25824239	2404	2396	Ø4	Ø4	50X13	55.1Kg
PMZ2582430	2404	2994	Ø4	Ø4	50X13	69.3Kg
PMZ2582436	2404	3592	Ø4	Ø4	50X13	83.14Kg

PROMAX UTRAMESH - 30, 40, 50, 65 VARI PITCH BOTH SIDE - 2X40 PITCH CENTRALLY - SUIT POST CENTRES 2440

PMZ3582424ULTRA	2404	2396	Ø5.6	Ø4	75X13	60.3Kg
PMZ3582430ULTRA	2404	2994	Ø5.6	Ø4	75X13	75.3Kg

Rails - 2410 Length - Hot Dip Galvanised

CODE	DESCRIPTION	SIZE	WEIGHT
PP BREA504GH	STD. RAIL - MESH SLOTS ONLY	50X50X4 EA	9.0Kg
PP TREA504GH	TOP RAIL - MESH SLOTS + CONCERTINA SLOTS	50X50X4 EA	9.0Kg

Discounts Available for Bulk Quantities

www.profence.com.au

PROMAX MESH FENCING

Post Extensions - 50x50x5 EA - Hot Dip Galvanised

- Barbed wire extensions are available in straight or cranked arrangements.
- Due to the extensive number of specified barbed rows and wire spacing required all extensions are made to suit.
- Each extension has standardised attachment points to suit the pre punched holes on the T post.
- For straight extensions corners are dealt with by providing extended corner posts to alleviate straining issues.

Fasteners - Galvanised

CODE	DESCRIPTION	WEIGHT/100
PM830G	MESH FIX - M8 X 30 CUP HEAD BOLT	2.15Kg
PSNM8G	MESH FIX - M8 SHEAR NUT	1.3Kg
PFCG	MESH FIX - MESH CLIP	1.0Kg
PRUC	CONCERTINA RAZOR TAPE FIXING CLIP	1.625Kg
PP M12 30 HTG	EXTENSION FIX - M12X30 CUP HEAD BOLT - 8.8 HI TENSILE	4.35Kg
PSNM12G	EXTENSION FIX - M12 SHEAR NUT	2.7Kg
DWG12MM	EXTENSION FIX - M12 FLAT WASHER	0.7Kg

- Mesh fasteners per panel - 2400 Fence = 40, 2700 Fence = 42, 3000 Fence = 44, 3600 Fence = 48

Fibreglass Posts - Isophthalic Polyester Resin - Grey

CODE	DESCRIPTION	WEIGHT
PP FIB 4500	203x203x9.5mm 'I' BEAM - 4500mm LONG	43.5Kg
PPSCRTUBE	100x100x6mm TUBE - 4500mm LONG	29.04Kg

- Commonly used for electrical isolation panels.

Accessories

CODE	DESCRIPTION	WEIGHT
BARBED WIRE		
WIRE BARB 157 HT 500M	BARBED WIRE - HI TENSILE 1.57 @ 500M - GAL	23.5Kg
WIRE BARB 250 GH	BARBED WIRE - IOWA SOFT 2.50 @ 400M - GAL	45.0Kg
CONCERTINA RAZOR TAPE - GAL		
PRT SB 56 550C3	Ø550 SHORT BARB - 8.4M @ 300 CENTRES - 5.6M @ 200 CENTRES	9.75Kg
PRT LB 56 760C3	Ø760 LONG BARB - 8.4M @ 300 CENTRES	13.23Kg
FLAT LOOP RAZOR TAPE - GAL		
PRT SB 45 550F	Ø550 SHORT BARB - 45 LOOPS - 13M @ 50% OVERLAP	7.75Kg
BULLDOG SPIKE TOPPING - HDG		
PBRT	TOPPING STRIP - H50xW110 - 800 LONG - 2 x OVERLAP FIXING	1.1Kg

Gates - Hot Dip Galvanised

- Standard sizes include - 1.2M PA, 4.8M double gate (leaf max 2400 wide), 6M double gate (2 part bolt on leaf).
- Gates to match fence height and customer specifications are manufactured to suit and priced accordingly.
- Single PA gates are made as a post, gate and lock assembly and installed as one unit.
- Double gates are supplied with posts, gates, hinges and locks. Gate leaves over 2400 wide are made in bolt together sections for ease of transport or export.

Discounts Available for Bulk Quantities

www.profence.com.au

HIGH SECURITY WELDED WIRE STEEL MESH SHEETS

Promax 358 Varimesh Sheets - Ø4 Wire - 75x13 Centres

CODE	SHEET (WxH)	FINISH	STOCK	WEIGHT	PRICE	P/COAT
PMZ3582424	2404 x 2396mm	ZALCOTE	YES	51.5Kg		
PMZ3582427	2404 x 2695mm	ZALCOTE	NO	57.9Kg		
PMZ3582430	2404 x 2994mm	ZALCOTE	YES	64.3Kg		
PMZ3582432	2404 x 3200mm	ZALCOTE	YES	68.7Kg		
PMZ3582436	2404 x 3592mm	ZALCOTE	YES	77.0Kg		
PMZ3582440	2404 x 3995mm	ZALCOTE	YES	85.6Kg		
PMZ3582445	2404 x 4500mm	ZALCOTE	NO	95.3Kg		
PMZ3582450	2404 x 5000mm	ZALCOTE	NO	105.9Kg		

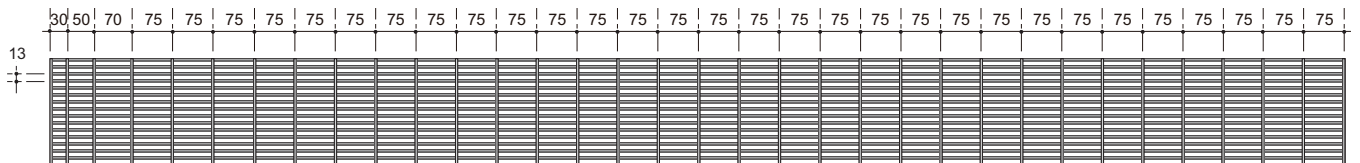

Promax 258 (Gantry Mesh) Mesh Sheets - Ø4 Wire - 50x13 Centres

CODE	SHEET (WxH)	FINISH	STOCK	WEIGHT	PRICE	P/COAT
PMZ2582424	2404 x 2396mm	ZALCOTE	YES	55.2Kg		
PMZ2582430	2404 x 2994mm	ZALCOTE	NO	69.36Kg		
PMZ2582436	2404 x 3592mm	ZALCOTE	NO	83.14Kg		

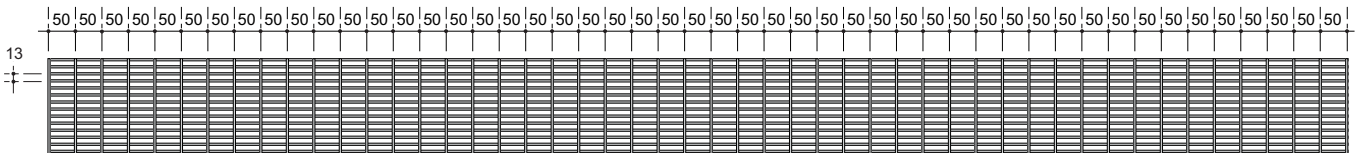

Ausgrid (EA) Mesh Sheets - Ø5 Wire - 75x25 Centres

CODE	SHEET (WxH)	FINISH	STOCK	WEIGHT	PRICE	P/COAT
PMB7525EA	2405 X 3000mm	BRIGHT	NO	60.0Kg		
PMZ7525EAZL	2405 X 3000mm	ZALCOTE	YES	64.8Kg		
PMB7525EAGH	2405 X 3000mm	HDG	NO	65.0Kg		

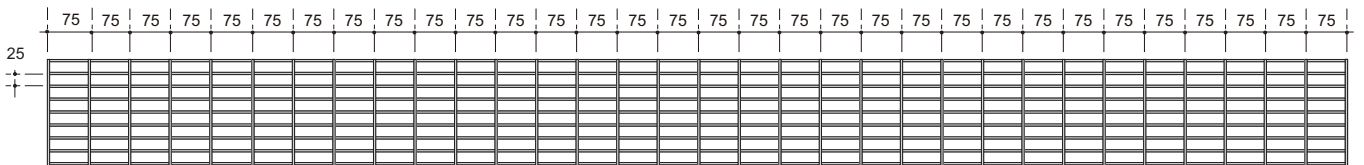

Promax Ultra Mesh Sheets - Ø5.6 x Ø4 Wire

CODE	SHEET (WxH)	FINISH	STOCK	WEIGHT	PRICE	P/COAT
PMZ3582424ULTRA	2400 X 2400mm	ZALCOTE	NO	60.3Kg		
PMZ3582430ULTRA	2400 X 3000mm	ZALCOTE	NO	75.3Kg		

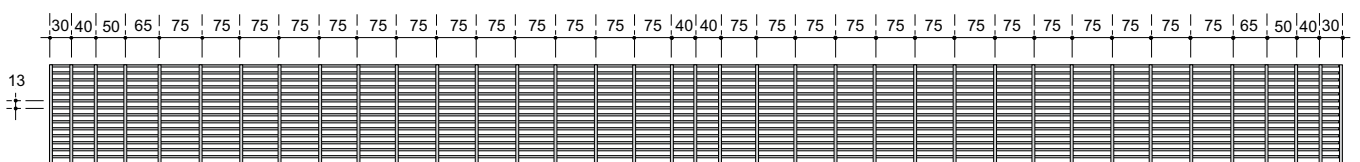

STEEL MESH PRODUCTS

General Purpose Welded Wire Mesh Sheets - Standard Galvanised

CODE	WIRE	SIZE(CENTRES)	SHEET (WxH)	PACK	STOCK	WEIGHT	PRICE
MP112	Ø2.5mm	25x25mm	2400 x 3000mm	30	YES	23.2Kg	
MP112HS	Ø2.5mm	25x25mm	2000 x 1200mm	30	YES	7.5Kg	
MP114	Ø3.15mm	25x25mm	2400 x 3000mm	30	YES	34.6Kg	
MP224	Ø4.0mm	50x50mm	2400 x 3000mm	50	YES	28.8Kg	
MP224H	Ø4.0mm	50x50mm	2000 x 1200mm	50	YES	9.8Kg	
MP224HS	Ø4.0mm	50x50mm	2400 x 1200mm	50	YES	11.8Kg	
MP234	Ø4.0mm	50x75mm	2400 x 3000mm	50	YES	24.1Kg	
MP234HS	Ø4.0mm	50x75mm	2000 x 1200mm	50	YES	8.2Kg	
MP444	Ø4.0mm	100x100mm	2400 x 3000mm	50	YES	14.7Kg	
MP444HS	Ø4.0mm	100x100mm	2000 x 1200mm	50	YES	5.1Kg	
MP225	Ø5.0mm	50x50mm	2400 x 3000mm	50	YES	45.2Kg	
MP235	Ø5.0mm	50x75mm	2400 x 3000mm	50	YES	37.9Kg	
MP445	Ø5.0mm	100x100mm	2400 x 3000mm	50	YES	23.1Kg	
MP445A	Ø5.6mm	100x100mm	2400 x 3000mm	50	NO	28.9Kg	



CUSTOM SHEET & APPERTURE SIZES AVAILABLE SUBJECT TO QUANTITY & SPECIFICATION

Farm Yard Mesh Sheets - Galvanised

CODE	WIRE	MESH (CENTRES)	SHEET (WxH)	STOCK	WEIGHT	PRICE
SHEEP YARD MESH						
SYM900	Ø5mm	100x250mm	6000x900mm	YES	12.70Kg	
SYM1100	Ø5mm	100x250mm	6000x1100mm	YES	15.33Kg	
FARM GATE INFILL MESH						
FGI8	Ø5.0mm	100x200mm	2400x1100mm	YES	6.6Kg	
FGI10	Ø5.0mm	100x200mm	3000x1100mm	YES	8.25Kg	
FGI12	Ø5.0mm	100x200mm	3600x1100mm	YES	9.8Kg	

Discounts Available for Bulk Quantities

www.profence.com.au

STEEL MESH PRODUCTS

Stainless Steel Welded Wire Mesh Sheets

CODE	WIRE	SIZE(CENTRES)	SHEET (WxH)	GRADE	STOCK	WEIGHT	PRICE
SSMP001	Ø3.0mm	25x25mm	2400 x 1200mm	304	NO	12.9Kg	
SSMP006	Ø3.0mm	25x25mm	2400 x 1200mm	316	NO	12.9Kg	
SSMP002	Ø3.0mm	40x40mm	2400 x 1200mm	304	NO	8.1Kg	
SSMP007	Ø3.0mm	40x40mm	2400 x 1200mm	316	NO	8.1Kg	
SSMP003	Ø3.0mm	50x50mm	2400 x 1200mm	304	NO	6.5Kg	
SSMP008	Ø3.0mm	50x50mm	2400 x 1200mm	316	NO	6.5Kg	
SSMP004	Ø4.0mm	50x50mm	2400 x 1200mm	304	NO	11.7Kg	
SSMP009	Ø4.0mm	50x50mm	2400 x 1200mm	316	NO	11.7Kg	
SSMP005	Ø6.0mm	100x100mm	2400 x 1200mm	304	NO	13.5Kg	
SSMP010	Ø6.0mm	100x100mm	2400 x 1200mm	316	NO	13.5Kg	



Custom stainless steel mesh sheets from minimum 4mm wire are available on request. Maximum width 2400mm and maximum height 3000mm. Minimum quantities apply.

Welded Wire Mesh Rolls - Galvanised

CODE	WIRE	SIZE(CENTRES)	ROLL	STOCK	WEIGHT	PRICE
RODENT AND SNAKE MESH						
AUSMS06	Ø0.6mm	6.5x6.5mm	600mm x 30M	YES	11.9KG	
AUSMS09	Ø0.6mm	6.5x6.5mm	900mm x 30M	YES	18.5KG	
AUSMS10	Ø1.0mm	6.5x6.5mm	1000mm x 30M	YES	65KG	



Discounts Available for Bulk Quantities

www.provence.com.au

BANKSIA FENCING (BORONIA)

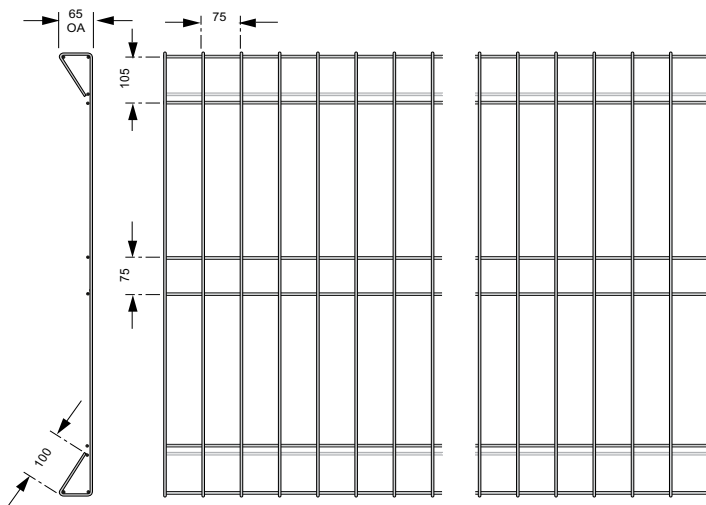

Banksia Fencing (Boronia) - Complies with AS2423-2002

CODE	DESCRIPTION	WEIGHT	STOCK	GAL	P/COAT
PANELS - Ø5mm WELDED WIRE					
BAPL2409	HEIGHT 900mm - WIDTH 2400mm - ZALCOTE	9.6Kg	YES		
BAPL2412	HEIGHT 1200mm - WIDTH 2400mm - ZALCOTE	11.2Kg	YES		
GATES - FRAME 25x25x1.2mm - ALL HEIGHT AND WIDTH DIMENSIONS ARE ACTUAL					
BASD1009	SINGLE GATE - H915 x W960mm - HOT DIP GALVANISED	7.2Kg	YES		
BASD1609	SINGLE GATE - H915x W1480mm - HOT DIP GALVANISED	10Kg	YES		
BASD1012	SINGLE GATE - H1215 x W960mm - HOT DIP GALVANISED	8.8Kg	YES		
BASD1612	SINGLE GATE - H1215 x W1485mm - HOT DIP GALVANISED	12.2Kg	YES		
• Double gate comprises of 2 single gate leaves					
POSTS - 50x50x1.6mm					
PST 5050 150 GS	POST - 50 x 50 x 1500mm - SUIT 900mm PANEL - PREGAL	4Kg	YES		
PST 5050 190 GS	POST - 50 x 50 x 1900mm - SUIT 1200mm PANEL - PREGAL	5Kg	YES		
FLANGED POSTS - 50x50x1.6mm					
PSTF 5050 900 GS	FLANGEPOST 50 x 50 x 1000mm - SUIT 900mm PANEL - PREGAL	4Kg	YES		
PSTF 5050 120 GS	FLANGEPOST 50 x 50 x 1300mm - SUIT 1200mm PANEL - PREGAL	5Kg	YES		
FITTINGS - NOT INCLUDED IN PANEL/POST PRICES - PLEASE ORDER SEPARATELY					
SCP6G	PANEL FIXING 6 PACK (6 CLIPS + 6 TEK SCREWS) - GALVANISED	0.25Kg	YES		
SCP18G	PANEL FIXING 18 PACK (18 CLIPS + 18 TEK SCREWS) - GALVANISED	0.5Kg	YES		
SCP30G	PANEL FIXING 30 PACK (30CLIPS + 30 TEK SCREWS) - GALVANISED	1.0Kg	YES		
DPC5050BL	POST CAP 50 x 50mm - BLACK PLASTIC		YES		
S STD SG PK G	SINGLE GATE PACK - 2 HINGES, 'D' LATCH & STRIKER, 2 GATE CAPS		YES		
S STD DG PK G	DBLE GATE PACK - 4 HINGES, 'D' LATCH & STRIKER, DROP BOLT, 4 GATE CAPS		YES		

Discounts Available for Bulk Quantities

www.profence.com.au

GARDEN FENCING

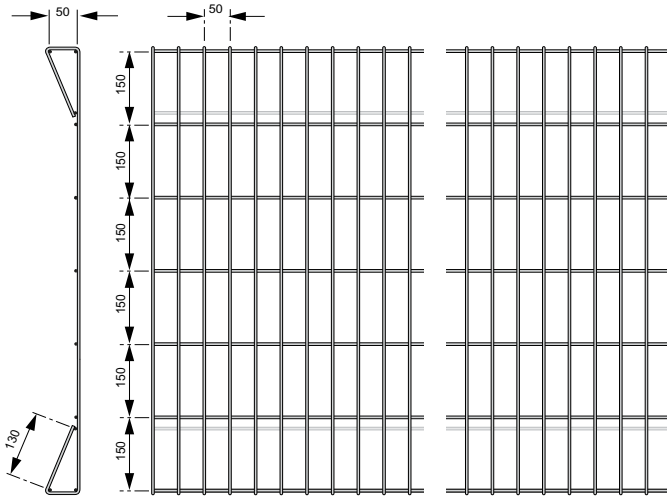

STEELMESH FENCING

Garden Fencing - Complies with AS2423-2002

CODE	DESCRIPTION	WEIGHT	STOCK	GAL	P/COAT
PANELS - Ø5mm WELDED WIRE					
SGP 075 240 ZL	HEIGHT 750mm - WIDTH 2400mm - ZALCOTE	11.2Kg	NO		
SGP 090 240 ZL	HEIGHT 900mm - WIDTH 2400mm - ZALCOTE	13.7Kg	YES		
SGP 120 240 ZL	HEIGHT 1200mm - WIDTH 2400mm - ZALCOTE	16.7Kg	YES		
SGP 150 240 ZL	HEIGHT 1500mm - WIDTH 2400mm - ZALCOTE	19.7Kg	YES		
SGP 180 240 ZL	HEIGHT 1800mm - WIDTH 2400mm - ZALCOTE	22.7Kg	YES		

GATES - NOTE: ALL GATE HEIGHT AND WIDTH DIMENSIONS ARE ACTUAL

SGSG 090 100 GH	SINGLE GATE - H900 x W960mm - HOT DIP GALVANISED	8.5Kg	YES		
SGSG 090 150 GH	SINGLE GATE - H900 x W1460mm - HOT DIP GALVANISED	11.5Kg	YES		
SGSG 120 100 GH	SINGLE GATE - H1200 x W960mm - HOT DIP GALVANISED	10.2Kg	YES		
SGSG 120 150 GH	SINGLE GATE - H1200 x W1460mm - HOT DIP GALVANISED	13.8Kg	YES		
SGSG 150 100 GH	SINGLE GATE - H1500 x W960mm - HOT DIP GALVANISED	13Kg	YES		
SGSG 150 150 GH	SINGLE GATE - H1500 x W1460mm - HOT DIP GALVANISED	16.4Kg	YES		
SGSG 180 100 GH	SINGLE GATE - H1800 x W960mm - HOT DIP GALVANISED	14.2Kg	YES		
SGSG 180 150 GH	SINGLE GATE - H1800 x W1460mm - HOT DIPPED GALVANISED	19.5Kg	YES		

• Double gate comprises of 2 single gate leaves. Hinges extra see below.

POSTS

PST 5050 150 GS	POST - 50 x 50 x 1500mm - PREGAL	4Kg	YES		
PST 5050 190 GS	POST - 50 x 50 x 1900mm - PREGAL	5Kg	YES		
PST 5050 210 GS	POST - 50 x 50 x 2100mm - PREGAL	6Kg	YES		
PST 5050 240 GS	POST - 50 x 50 x 2400mm - PREGAL	7Kg	YES		

FITTINGS - NOT INCLUDED IN PANEL/POST PRICES - PLEASE ORDER SEPARATELY

SCP6G	PANEL FIXING 6 PACK (6 CLIPS + 6 TEK SCREWS) - GALVANISED	0.25Kg	YES		
SCP18G	PANEL FIXING 18 PACK (18 CLIPS + 18 TEK SCREWS) - GALVANISED	0.5Kg	YES		
SCP30G	PANEL FIXING 30 PACK (30CLIPS + 30 TEK SCREWS) - GALVANISED	1.0Kg	YES		
DPC5050BL	POST CAP 50 x 50mm - BLACK PLASTIC		YES		
S STD SG PK G	SINGLE GATE PACK - 2 HINGES, 'D' LATCH & STRIKER, 2 GATE CAPS		YES		
S STD DG PK G	DBLE GATE PACK - 4 HINGES, 'D' LATCH & STRIKER, DROP BOLT, 4 GATE CAPS		YES		

BOULEVARD SAFETY & SECURITY MESH FENCING (ACACIA, CLASSIC)

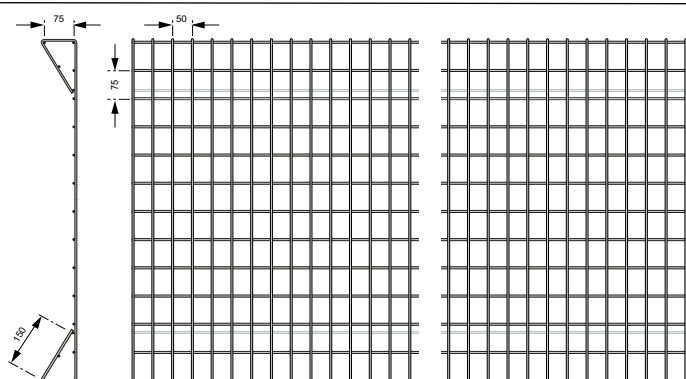

Boulevard Safety & Security Mesh Fencing (Acacia, Classic) - Complies with AS2423-2002

CODE	DESCRIPTION	WEIGHT	STOCK	GAL	P/COAT
------	-------------	--------	-------	-----	--------

PANELS - Ø5mm WELDED WIRE

SBP 090 240 ZL	HEIGHT 900mm - WIDTH 2400mm - ZALCOTE	16.8Kg	YES		
SBP 120 240 ZL	HEIGHT 1200mm - WIDTH 2400mm - ZALCOTE	20.5Kg	YES		
SBP 180 240 ZL	HEIGHT 1800mm - WIDTH 2400mm - ZALCOTE	26.2Kg	YES		

GATES - FRAME 25NB - ALL HEIGHT AND WIDTH DIMENSIONS ARE ACTUAL - EL= EACH LEAF

SBSG 090 100 GH	SINGLE GATE - H900 x W975mm - HOT DIP GALVANISED	13Kg	YES		
SBSG 120 100 GH	SINGLE GATE - H1200 x W975mm - HOT DIP GALVANISED	15.4Kg	YES		
SBSG 180 100 GH	SINGLE GATE - H1800 x W975mm - HOT DIP GALVANISED	19.6Kg	YES		
SBDG 090 300 GH	DOUBLE GATE - 2 OF H900 x W1475mm GATE LEAVES - HDG	18Kg/EL	YES	PR	PR
SBDG 120 300 GH	DOUBLE GATE - 2 OF H1200 x W1475mm GATE LEAVES - HDG	21.2Kg/EL	YES	PR	PR
SBDG 180 300 GH	DOUBLE GATE - 2 OF H1800 x W1475mm GATE LEAVES - HDG	26.6Kg/EL	YES	PR	PR

POSTS - ALL POSTS ARE STRAIGHT AND FROM EXTRA LIGHT PIPE & COMPLY WITH AS1074 - CAPS NOT INCLUDED

PST SX 40NB OB 1500	POST - 40NB x 1500mm - SUIT 900mm PANEL - PREGAL	4.1Kg	YES		
PST SX 50NB OB 1600	POST - 50NB x 1600mm - SUIT 900mm PANEL - PREGAL	5.5Kg	YES		
PST SX 40NB OB 1800	POST - 40NB x 1800mm - SUIT 1200mm PANEL - PREGAL	6Kg	YES		
PST SX 50NB OB 1980	POST - 50NB x 1980mm - SUIT 1200mm PANEL - PREGAL	6.9Kg	YES		
PST SX 80NB OB 1980	POST - 80NB x 1980mm - SUIT 1200mm PANEL - PREGAL	11.4Kg	YES		
PST SX 40NB OB 2400	POST - 40NB x 2400mm - SUIT 1800mm PANEL - PREGAL	6.6Kg	YES		
PST SX 50NB OB 2600	POST - 50NB x 2600mm - SUIT 1800mm PANEL - PREGAL	9Kg	YES		
PST SX 80NB OB 2600	POST - 80NB x 2600mm - SUIT 1800mm PANEL - PREGAL	15Kg	YES		

FITTINGS - NOT INCLUDED IN PANEL/POST PRICES - PLEASE ORDER SEPARATELY

SCP6G	PANEL FIXING 6 PACK (6 CLIPS + 6 TEK SCREWS) - GAL.	0.25Kg	YES		
SCP18G	PANEL FIXING 18 PACK (18 CLIPS + 18 TEK SCREWS) - GAL.	0.5Kg	YES		
SCP30G	PANEL FIXING 30 PACK (30CLIPS + 30 TEK SCREWS) - GAL.	1.0Kg	YES		
DTH4025	2 PART HINGE - POST 40NB / GATE 25NB - GALVANISED		YES		
DTH5025	2 PART INTERLOCKING HINGE - POST 50NB / GATE 25NB - GAL.		YES		
DTH8025	2 PART INTERLOCKING HINGE - POST 80NB / GATE 25NB - GAL.		YES		
DCAC29	'D' LATCH - GALVANISED		YES		
DBTS28R	'D' LATCH STRIKER - GALVANISED		YES		
DCAC22	DOUBLE GATE BOW - GALVANISED		YES		
DB15LG	DROP BOLT - GALVANISED		YES		

Panels can be manufactured in Hot Dip Galvanised finish subject to minimum order requirements.

BOULEVARD SECURITY FENCING

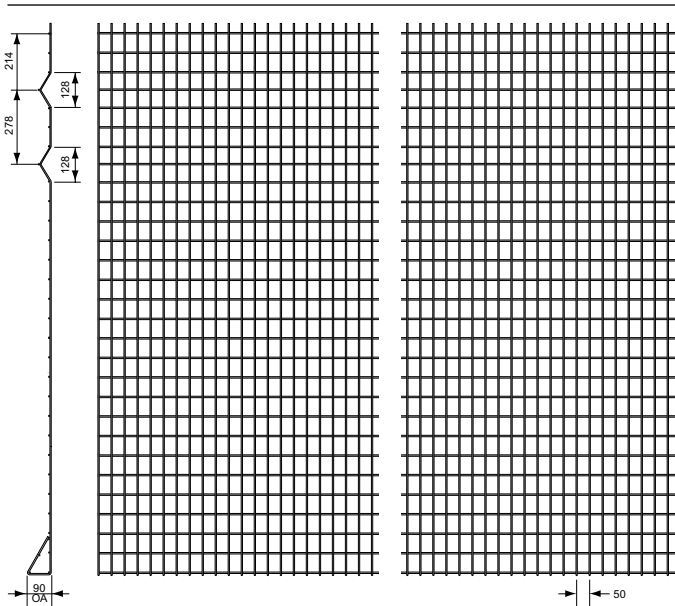

STEELMESH FENCING

Boulevard Security Fencing - Complies with AS2423-2002 - DET Specification - Contract 0601006

CODE	DESCRIPTION	WEIGHT	STOCK	GAL	P/COAT
MESH PANELS - Ø5mm WELDED WIRE					
BSP 210 240 ZL	HEIGHT 2100mm - WIDTH 2400mm - ZALCOTE	29.7Kg	NO		
BSP 240 240 ZL	HEIGHT 2400mm - WIDTH 2400mm - ZALCOTE	33.5Kg	NO		

GATES - FRAME 32NB x 3.2mm - BROADHURST DOUBLE LOCK BOX KIT & DROP BOLT + HINGE COLLAR - GATE SIZES ACTUAL

BSG 210 120 GH	SINGLE GATE - H2100 x W1200mm - HOT DIP GALVANISED	33Kg	NO		
BSG 240 210 GH	SINGLE GATE - H2400 x W1200mm - HOT DIP GALVANISED	40Kg	NO		
BSG 210 480 GH	DOUBLE GATE - 2 X H2100 x W2400mm GATE LEAVES - HDG	148.3Kg	NO		
BSG 240 480 GH	DOUBLE GATE - 2 X H2400 x W2400mm GATE LEAVES - HDG	155.4Kg	NO		

POST ASSEMBLIES - INCLUDES 8 x Ø10mm PANEL ATTACHMENT HOLES + GALVANISED CAP

BSPS5030	POST - 50NB x 3000mm - SUIT 2100mm PANEL - MED. GAL - AS1074	15.6Kg	NO		
BSPS5032	POST - 50NB x 3250mm - SUIT 2400mm PANEL - MED. GAL - AS1074	16.8Kg	NO		
BSPS5036	POST - 50NB x 3600mm - SUIT 2400mm PANEL - MED. GAL - AS1074	18.7Kg	NO		
BSPS10030	GATE POST - 100NB x 3000mm - 2100mm PANEL - MEDIUM GAL - AS1074	37.2Kg	NO		
BSPS10036	GATE POST - 100NB x 3600mm - 2400mm PANEL - MEDIUM GAL - AS1074	44.7Kg	NO		

FITTINGS - NOT INCLUDED IN PANEL/POST/GATE PRICES - PLEASE ORDER SEPARATELY

DUC8/10G	FENCE PANEL 'U' CLIP - GALVANISED		YES		
DH08090G	M8 x 90mm HEXAGONAL BOLT & NUT - SUIT 50NB POST - GALVANISED		YES		
DH08150G	M8 x 150mm HEXAGONAL BOLT & NUT - SUIT 100NB POST - GALVANISED		YES		
DSH10032	TWO PART HINGE & ATTACHMENT 100NB x 32NB - GALVANISED		YES		

CONFORMS TO DEPARTMENT OF COMMERCE SCHOOL SECURITY FENCING SPECIFICATION TYPE 3 - CONTRACT NO. 0601006

Discounts Available for Bulk Quantities

www.profence.com.au

ROLL TOP POOL SAFETY FENCING (WATTLE)

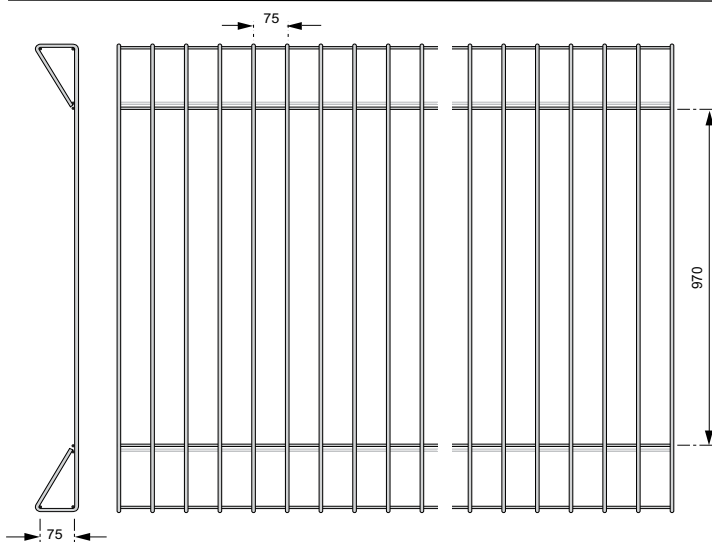

Pool Fencing (Wattle) - Complies with AS2423-2002 SECTION 8 - AS1926-2007

CODE	DESCRIPTION	WEIGHT	STOCK	GAL	P/COAT
PANEL - Ø5mm HORIZONTAL WIRE - Ø8mm VERTICAL WIRE					
SPP 120 240 GH	HEIGHT 1270mm - WIDTH 2400mm - HOT DIP GALVANISED	24Kg	YES		
SPP 150 240 GH	HEIGHT 1520mm - WIDTH 2400mm - HOT DIP GALVANISED	30Kg	YES		

GATES - FRAME 25x25x1.2 - NOTE: ALL HEIGHT AND WIDTH DIMENSIONS ARE ACTUAL

SPSG 125 100 GH	SINGLE GATE - H1260 x W960mm - HOT DIP GALVANISED	11Kg	YES		
SPSG 150 100 GH	SINGLE GATE - H1530 x W960mm - HOT DIP GALVANISED	15Kg	YES		

POSTS

PST 5050 190 GS	POST - 50 x 50 x 1.6 x 1900mm - PREGAL	5Kg	YES		
PST 5050 210 GS	POST - 50 x 50 x 1.6 x 2100mm - PREGAL	6Kg	YES		

FITTINGS - NOT INCLUDED IN PANEL/POST PRICES - PLEASE ORDER SEPARATELY

SCP6G	PANEL FIXING 6 PACK (6 CLIPS + 6 TEK SCREWS) - GAL.	0.25Kg	YES		
SCP18G	PANEL FIXING 18 PACK (18 CLIPS + 18 TEK SCREWS) - GAL.	0.5Kg	YES		
SCP30G	PANEL FIXING 30 PACK (30CLIPS + 30 TEK SCREWS) - GAL.	1.0Kg	YES		
DPC5050BL	POST CAP 50 x 50mm - BLACK PLASTIC		YES		-
S SPR SG PK G	SINGLE GATE PACK - 2 SPRING HINGES, 2 GATE CAPS		YES		
DMLTPS2BGA	MAGNA LATCH - SERIES 2		YES		-

TO PROVIDE MAXIMUM SAFETY POOL FENCING MUST BE INSTALLED TO THE REQUIREMENTS OF AS1926-2007 & PROPERLY MAINTAINED.

Discounts Available for Bulk Quantities

www.profence.com.au

ESPLANADE SWIMMING POOL SAFETY FENCING (WILLOW)

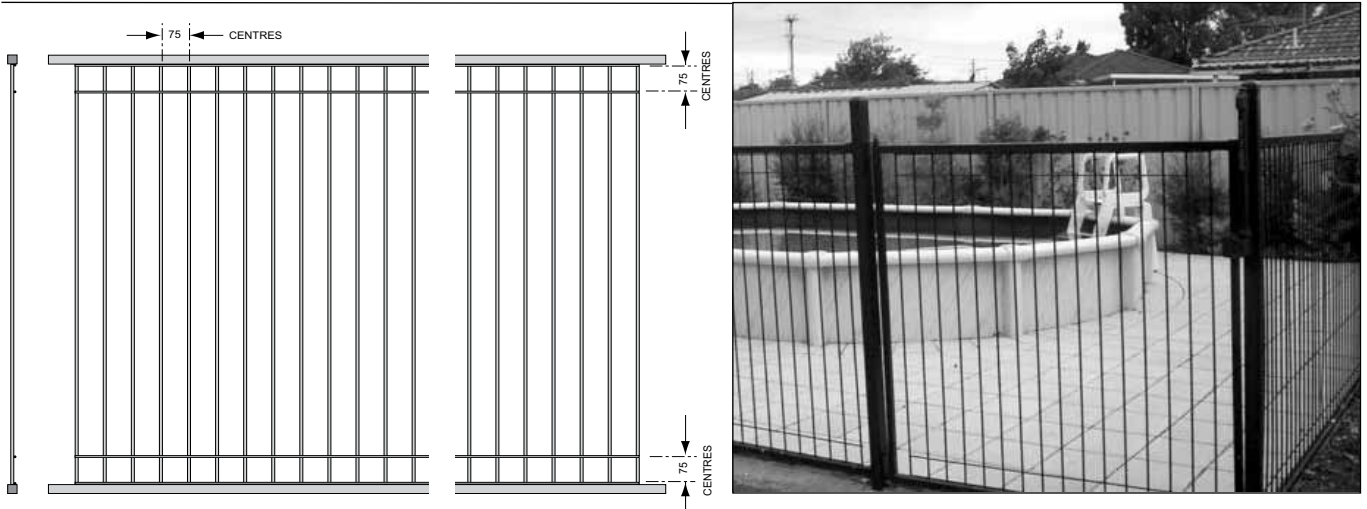

STEELMESH FENCING

Esplanade Fencing (Willow) - Complies with AS2423-2002 SECTION 8

CODE	DESCRIPTION	WEIGHT	STOCK	GAL	P/COAT
RESIDENTIAL APPLICATIONS - ALL HEIGHT & WIDTH DIMENSIONS ARE ACTUAL					
PANELS - 25 x 25 x 1.6mm RAILS - - Ø5mm HORIZONTAL WIRE - Ø8mm VERTICAL WIRE					
SEP1224R	HEIGHT 1200mm - WIDTH 2400mm - HOT DIP GALVANISED	22.1Kg	YES		
GATES - 25 x 25 x 1.6mm RAILS - ALL HEIGHT AND WIDTH DIMENSIONS ARE ACTUAL					
SESG 120 100 R	SINGLE GATE - H1200 x W960mm - HOT DIP GALVANISED	11Kg	YES		
HEAVY DUTY COMMERCIAL APPLICATIONS - ALL HEIGHT & WIDTH DIMENSIONS ARE ACTUAL					
PANELS - 30 x 30 x 1.6mm RAILS - Ø5mm HORIZONTAL WIRE - Ø8mm VERTICAL WIRE					
SEP 130 240 GH	HEIGHT 1210mm - WIDTH 2400mm - HOT DIP GALVANISED	25Kg	NO		
GATES - 30 x 30 x 1.6mm RAILS					
SESG 130 090 GH	SINGLE GATE - H1210 x W960mm - HOT DIP GALVANISED	11Kg	NO		
POSTS					
PST 5050 190 GS	POST - 50 x 50 x 1.6 x 1900mm - PREGAL	5Kg	YES		
FITTINGS					
RESIDENTIAL - NOT INCLUDED IN PANEL/POST PRICES - PLEASE ORDER SEPARATELY					
SEBP425G	25x25 RAIL BRACKET 4 PACK (4 BRACKETS + 8 TEK SCREWS) - GAL		YES		
SEBP1225G	25x25 RAIL BRACKET 12 PACK (12 BRACKETS + 24 TEK SCREWS) - GAL		YES		
SEBP2025G	25x25 RAIL BRACKET 20 PACK (20 BRACKETS + 40 TEK SCREWS) - GAL		YES		
COMMERCIAL - NOT INCLUDED IN PANEL/POST PRICES - PLEASE ORDER SEPARATELY					
SEBP430G	30x30 RAIL BRACKET 4 PACK (4 BRACKETS + 8 TEK SCREWS) - GAL		YES		
SEBP1230G	30x30 RAIL BRACKET 12 PACK (12 BRACKETS + 24 TEK SCREWS) - GAL		YES		
SEBP2030G	30x30 RAIL BRACKET 20 PACK (20 BRACKETS + 40 TEK SCREWS) - GAL		YES		
DPC5050BL	POST CAP 50 x 50mm - BLACK PLASTIC		YES		-
S SPR SG PK G	SINGLE GATE PACK - 2 SPRING HINGES, 2 GATE CAPS - GAL		YES		
DMLTPS2BGA	MAGNA LATCH - SERIES 2		YES		-

TO PROVIDE MAXIMUM SAFETY POOL FENCING MUST BE INSTALLED TO THE REQUIREMENTS OF AS1926-2007 & PROPERLY MAINTAINED.

Discounts Available for Bulk Quantities

www.profence.com.au

DIAMOND FENCE CHAINWIRE

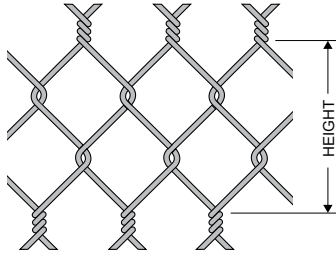

BARB / BARB SELVEDGE = BB

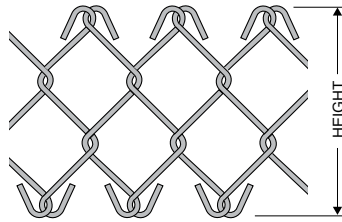

KNUCKLE / KNUCKLE SELVEDGE = KK

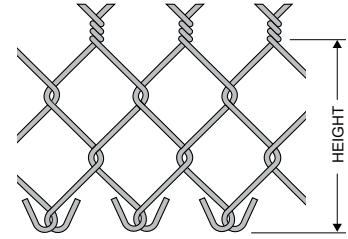

KNUCKLE / BARB SELVEDGE = KB

Specifications

- Nominated chainwire length is a strained length of roll.
- Knuckle & barb selvedge is client nominated at time of purchase
- Mesh size is the maximum distance between the wires forming the parallel sides of the diamond
- Chainwire height measurement is from knuckle to knuckle or to the **first twist** of the barbs.
- Galvanising: Standard Grade - W02Z to AS1650-2.2, Heavy Grade - W10Z to AS 1725-2.2

Tolerances

Nominal Core Wire Diameter

2.50mm

3.15mm

Nominal Outside Diameter of Plastic Coated Wires

3.40mm

4.15mm

Linear Tolerance of PVC Coated Wires

+/- 0.08mm

+/- 0.10mm

Concentricity Tolerance of PVC Coated Wires

+/- 25%

+/- 25%

Width Tolerance of Chainwire Products

+/- 25mm

+/- 25mm



NOTE: \$45 CUTTING FEE APPLIES FOR CUT ROLLS

- Chainwire marked "YES" in the stock column is subject to peak demand & may not ALWAYS be available.
- Non stock items are made to order and are subject to minimum order quantities & extended lead times.
- Contact Protective Fencing for availability of other combinations of wire types and diameters. Minimum order quantities & extended lead times may apply.

Chainwire 60 x 2.24 Mesh - Temporary Fencing Applications

CODE	HEIGHT	MESH	FINISH	SELVEDGE	STOCK	STD ROLL	ROLL KG	PRICE/M
C180 060 224 GS KK/20	1800mm	60x2.24mm	STANDARD GAL	KK	YES	20M	38Kg	
C210 060 224 GS KK	2100mm	60x2.24mm	STANDARD GAL	KK	YES	20M	57Kg	

www.profence.com.au

Chainwire 50 x 2.50 Mesh - Security Fencing Applications

CODE	HEIGHT	MESH	FINISH	SELVEDGE	STOCK	STD ROLL	ROLL KG	PRICE/M
50 x 2.50 MESH - HEAVY GALVANISED								
C090 050 250 GH KK	900mm	50x2.50mm	HEAVY GAL	KK	YES	15M	22Kg	
C120 050 250 GH KK	1200mm	50x2.50mm	HEAVY GAL	KK	YES	15M	29Kg	
C150 050 250 GH KK	1500mm	50x2.50mm	HEAVY GAL	KK	YES	15M	36Kg	
C150 050 250 GH KB	1500mm	50x2.50mm	HEAVY GAL	KB	YES	15M	36Kg	
C180 050 250 GH BB	1800mm	50x2.50mm	HEAVY GAL	BB	NO	15M	43Kg	
C180 050 250 GH KB	1800mm	50x2.50mm	HEAVY GAL	KB	YES	15M	43Kg	
C180 050 250 GH KK	1800mm	50x2.50mm	HEAVY GAL	KK	YES	15M	43Kg	
C210 050 250 GH BB	2100mm	50x2.50mm	HEAVY GAL	BB	NO	15M	49Kg	
C210 050 250 GH KB	2100mm	50x2.50mm	HEAVY GAL	KB	YES	15M	49Kg	
C210 050 250 GH KK	2100mm	50x2.50mm	HEAVY GAL	KK	YES	15M	49Kg	
C240 050 250 GH BB	2400mm	50x2.50mm	HEAVY GAL	BB	NO	15M	56Kg	
C240 050 250 GH KB	2400mm	50x2.50mm	HEAVY GAL	KB	NO	15M	56Kg	
C240 050 250 GH KK	2400mm	50x2.50mm	HEAVY GAL	KK	YES	15M	56Kg	
C270 050 250 GH KB	2700mm	50x2.50mm	HEAVY GAL	KB	NO	15M	62Kg	
C270 050 250 GH KK	2700mm	50x2.50mm	HEAVY GAL	KK	YES	15M	62Kg	
50 x 2.50 MESH - BLACK PVC								
C090 050 250 PB KK	900mm	50x2.50mm	BLACK PVC	KK	YES	15M	28Kg	
C120 050 250 PB KK	1200mm	50x2.50mm	BLACK PVC	KK	YES	15M	34Kg	
C150 050 250 PB KB	1500mm	50x2.50mm	BLACK PVC	KB	NO	15M	43Kg	
C150 050 250 PB KK	1500mm	50x2.50mm	BLACK PVC	KK	YES	15M	43Kg	
C180 050 250 PB BB	1800mm	50x2.50mm	BLACK PVC	BB	NO	15M	49Kg	
C180 050 250 PB KB	1800mm	50x2.50mm	BLACK PVC	KB	YES	15M	49Kg	
C180 050 250 PB KK	1800mm	50x2.50mm	BLACK PVC	KK	YES	15M	49Kg	
C210 050 250 PB BB	2100mm	50x2.50mm	BLACK PVC	BB	NO	15M	61Kg	
C210 050 250 PB KB	2100mm	50x2.50mm	BLACK PVC	KB	YES	15M	61Kg	
C210 050 250 PB KK	2100mm	50x2.50mm	BLACK PVC	KK	YES	15M	61Kg	
C240 050 250 PB BB	2400mm	50x2.50mm	BLACK PVC	BB	NO	15M	69Kg	
C240 050 250 PB KB	2400mm	50x2.50mm	BLACK PVC	KB	YES	15M	69Kg	
C240 050 250 PB KK	2400mm	50x2.50mm	BLACK PVC	KK	YES	15M	69Kg	
C270 050 250 PB KB	2700mm	50x2.50mm	BLACK PVC	KB	NO	15M	77Kg	
C270 050 250 PB KK	2700mm	50x2.50mm	BLACK PVC	KK	YES	15M	77Kg	
50 x 2.50 MESH - GREEN PVC								
C090 050 250 PG KK	900mm	50x2.50mm	GREEN PVC	KK	YES	15M	28Kg	
C120 050 250 PG KK	1200mm	50x2.50mm	GREEN PVC	KK	YES	15M	34Kg	
C150 050 250 PG KB	1500mm	50x2.50mm	GREEN PVC	KB	NO	15M	43Kg	
C150 050 250 PG KK	1500mm	50x2.50mm	GREEN PVC	KK	YES	15M	43Kg	
C180 050 250 PG BB	1800mm	50x2.50mm	GREEN PVC	BB	NO	15M	49Kg	
C180 050 250 PG KB	1800mm	50x2.50mm	GREEN PVC	KB	YES	15M	49Kg	
C180 050 250 PG KK	1800mm	50x2.50mm	GREEN PVC	KK	YES	15M	49Kg	
C210 050 250 PG KB	2100mm	50x2.50mm	GREEN PVC	KB	NO	15M	61Kg	
C210 050 250 PG KK	2100mm	50x2.50mm	GREEN PVC	KK	NO	15M	61Kg	
C240 050 250 PG BB	2400mm	50x2.50mm	GREEN PVC	BB	NO	15M	69Kg	
C240 050 250 PG KB	2400mm	50x2.50mm	GREEN PVC	KB	NO	15M	69Kg	
C240 050 250 PG KK	2400mm	50x2.50mm	GREEN PVC	KK	NO	15M	69Kg	
C270 050 250 PG KB	2700mm	50x2.50mm	GREEN PVC	KB	NO	15M	77Kg	
C270 050 250 PG KK	2700mm	50x2.50mm	GREEN PVC	KK	NO	15M	77Kg	

Chainwire 50 x 3.15 Mesh - Heavy Duty Security Fencing Applications

CODE	HEIGHT	MESH	FINISH	SELVEDGE	STOCK	STD ROLL	ROLL KG	PRICE/M
50 x 3.15 MESH - HEAVY GALVANISED								
C090 050 315 GH KK	900mm	50x3.15mm	HEAVY GAL	KK	NO	15M	36Kg	
C120 050 315 GH KK	1200mm	50x3.15mm	HEAVY GAL	KK	YES	15M	49Kg	
C150 050 315 GH KB	1500mm	50x3.15mm	HEAVY GAL	KB	NO	15M	58Kg	
C150 050 315 GH KK	1500mm	50x3.15mm	HEAVY GAL	KK	YES	15M	58Kg	
C180 050 315 GH KB	1800mm	50x3.15mm	HEAVY GAL	KB	YES	10M	46Kg	
C180 050 315 GH KK	1800mm	50x3.15mm	HEAVY GAL	KK	YES	10M	46Kg	
C210 050 315 GH KB	2100mm	50x3.15mm	HEAVY GAL	KB	YES	10M	55Kg	
C210 050 315 GH KK	2100mm	50x3.15mm	HEAVY GAL	KK	YES	10M	55Kg	
C240 050 315 GH KB	2400mm	50x3.15mm	HEAVY GAL	KB	YES	10M	63Kg	
C240 050 315 GH KK	2400mm	50x3.15mm	HEAVY GAL	KK	YES	10M	63Kg	
C270 050 315 GH KB	2700mm	50x3.15mm	HEAVY GAL	KB	YES	10M	73Kg	
C270 050 315 GH KK	2700mm	50x3.15mm	HEAVY GAL	KK	YES	10M	73Kg	

50 x 3.15 MESH - BLACK PVC

C090 050 315 PB KK	900mm	50x3.15mm	BLACK PVC	KK	NO	15M	43Kg	
C120 050 315 PB KK	1200mm	50x3.15mm	BLACK PVC	KK	NO	15M	55Kg	
C150 050 315 PB KB	1500mm	50x3.15mm	BLACK PVC	KB	NO	15M	74Kg	
C150 050 315 PB KK	1500mm	50x3.15mm	BLACK PVC	KK	NO	15M	74Kg	
C180 050 315 PB KB	1800mm	50x3.15mm	BLACK PVC	KB	YES	10M	55Kg	
C180 050 315 PB KK	1800mm	50x3.15mm	BLACK PVC	KK	YES	10M	55Kg	
C210 050 315 PB KB	2100mm	50x3.15mm	BLACK PVC	KB	NO	10M	64Kg	
C210 050 315 PB KK	2100mm	50x3.15mm	BLACK PVC	KK	NO	10M	64Kg	
C240 050 315 PB KB	2400mm	50x3.15mm	BLACK PVC	KB	NO	10M	73Kg	
C240 050 315 PB KK	2400mm	50x3.15mm	BLACK PVC	KK	NO	10M	73Kg	
C270 050 315 PB KB	2700mm	50x3.15mm	BLACK PVC	KB	NO	10M	83Kg	
C270 050 315 PB KK	2700mm	50x3.15mm	BLACK PVC	KK	NO	10M	83Kg	

50 x 3.15 MESH - GREEN PVC

C090 050 315 PG KK	900mm	50x3.15mm	GREEN PVC	KK	NO	15M	43Kg	
C120 050 315 PG KK	1200mm	50x3.15mm	GREEN PVC	KK	NO	15M	55Kg	
C150 050 315 PG KB	1500mm	50x3.15mm	GREEN PVC	KB	NO	15M	74Kg	
C150 050 315 PG KK	1500mm	50x3.15mm	GREEN PVC	KK	NO	15M	74Kg	
C180 050 315 PG KB	1800mm	50x3.15mm	GREEN PVC	KB	NO	10M	55Kg	
C180 050 315 PG KK	1800mm	50x3.15mm	GREEN PVC	KK	NO	10M	55Kg	
C210 050 315 PG KB	2100mm	50x3.15mm	GREEN PVC	KB	NO	10M	64Kg	
C210 050 315 PG KK	2100mm	50x3.15mm	GREEN PVC	KK	NO	10M	64Kg	
C240 050 315 PG KB	2400mm	50x3.15mm	GREEN PVC	KB	NO	10M	73Kg	
C240 050 315 PG KK	2400mm	50x3.15mm	GREEN PVC	KK	NO	10M	73Kg	
C270 050 315 PG KB	2700mm	50x3.15mm	GREEN PVC	KB	NO	10M	83Kg	
C270 050 315 PG KK	2700mm	50x3.15mm	GREEN PVC	KK	NO	10M	83Kg	

Discounts Available for Bulk Quantities

www.profence.com.au

Chainwire 50 x 4.0 Mesh - Extreme Use Applications

CODE	HEIGHT	MESH	FINISH	SELVEDGE	STOCK	STD ROLL	ROLL KG	PRICE/M
50 x 4.0 MESH - HEAVY GALVANISED								
C060 050 400 GH KK	600mm	50x4.0mm	HEAVY GAL	KK	NO	10M	28Kg	
C180 050 400 GH KB	1800mm	50x4.0mm	HEAVY GAL	KB	NO	10M	76Kg	
C180 050 400 GH KK	1800mm	50x4.0mm	HEAVY GAL	KK	NO	10M	76Kg	

Chainwire 49 x 2.50 Mesh - Tennis Court Applications - Complies with AS1725: 2010

CODE	HEIGHT	MESH	FINISH	SELVEDGE	STOCK	STD ROLL	ROLL KG	PRICE/M
49 x 2.50 MESH - HEAVY GALVANISED								
C120 049 250 GH KK	1200mm	49x2.50mm	HEAVY GAL	KK	NO	15M	21Kg	
C300 049 250 GH KK	3000mm	49x2.50mm	HEAVY GAL	KK	YES	10M	51Kg	
C300 049 250 GH KB	3000mm	49x2.50mm	HEAVY GAL	KB	YES	10M	51Kg	
C360 049 250 GH KK	3600mm	49x2.50mm	HEAVY GAL	KK	YES	10M	63Kg	

49 x 2.50 MESH - BLACK PVC

C120 049 250 PB KK	1200mm	49x2.50mm	BLACK PVC	KK	YES	15M	23Kg	
C300 049 250 PB KK	3000mm	49x2.50mm	BLACK PVC	KK	YES	10M	58Kg	
C300 049 250 PB KB	3000mm	49x2.50mm	BLACK PVC	KB	YES	10M	58Kg	
C360 049 250 PB KK	3600mm	49x2.50mm	BLACK PVC	KK	YES	10M	70Kg	

49 x 2.50 MESH - GREEN PVC

C120 049 250 PG KK	1200mm	49x2.50mm	GREEN PVC	KK	NO	15M	23.5Kg	
C300 049 250 PG KK	3000mm	49x2.50mm	GREEN PVC	KK	NO	10M	58Kg	
C300 049 250 PG KB	3000mm	49x2.50mm	GREEN PVC	KB	NO	10M	58Kg	
C360 049 250 PG KK	3600mm	49x2.50mm	GREEN PVC	KK	NO	10M	70Kg	

Chainwire 49 x 3.15 Mesh - Tennis Court Applications - Complies with AS1725: 2010

CODE	HEIGHT	MESH	FINISH	SELVEDGE	STOCK	STD ROLL	ROLL KG	PRICE/M
49 x 3.15 MESH - HEAVY GALVANISED								
C120 049 315 GH KK	1200mm	49x3.15mm	HEAVY GAL	KK	NO	15M	34Kg	
C300 049 315 GH BB	3000mm	49x3.15mm	HEAVY GAL	BB	NO	10M	83Kg	
C300 049 315 GH KK	3000mm	49x3.15mm	HEAVY GAL	KK	NO	10M	83Kg	
C300 049 315 GH KB	3000mm	49x3.15mm	HEAVY GAL	KB	YES	10M	83Kg	
C360 049 315 GH KK	3600mm	49x3.15mm	HEAVY GAL	KK	NO	10M	102Kg	
C360 049 315 GH KK	3600mm	49x3.15mm	HEAVY GAL	KB	YES	10M	102Kg	

49 x 3.15 MESH - BLACK PVC

C120 049 315 PB KK	1200mm	49x3.15mm	BLACK PVC	KK	NO	15M	37.5Kg	
C300 049 315 PB KK	3000mm	49x3.15mm	BLACK PVC	KK	NO	10M	94.5Kg	
C300 049 315 PB KB	3000mm	49x3.15mm	BLACK PVC	KB	NO	10M	94.5Kg	
C360 049 315 PB KK	3600mm	49x3.15mm	BLACK PVC	KK	NO	10M	114Kg	

49 x 3.15 MESH - GREEN PVC

C120 049 315 PG KK	1200mm	49x3.15mm	GREEN PVC	KK	NO	15M	37.5g	
C300 049 315 PG KK	3000mm	49x3.15mm	GREEN PVC	KK	NO	10M	94.5Kg	
C300 049 315 PG KB	3000mm	49x3.15mm	GREEN PVC	KB	NO	10M	94.5Kg	
C360 049 315 PG KK	3600mm	49x3.15mm	GREEN PVC	KK	NO	10M	114Kg	

Chainwire 45 x 2.50 Mesh - Tennis Court Applications - Complies with AS1725: 2010

CODE	HEIGHT	MESH	FINISH	SELVEDGE	STOCK	STD ROLL	ROLL KG	PRICE/M
45 x 2.50 MESH - HEAVY GALVANISED								
C240 045 250 GH KK	2400mm	45x2.50mm	HEAVY GAL	KK	NO	10M	47Kg	
C300 045 250 GH KK	3000mm	45x2.50mm	HEAVY GAL	KK	NO	10M	58Kg	
C360 045 250 GH KK	3600mm	45x2.50mm	HEAVY GAL	KK	NO	10M	70Kg	
45 x 2.50 MESH - BLACK PVC								
C240 045 250 PB KK	2400mm	45x2.50mm	BLACK PVC	KK	NO	10M	57Kg	
C300 045 250 PB KK	3000mm	45x2.50mm	BLACK PVC	KK	NO	10M	71Kg	
C360 045 250 PB KK	3600mm	45x2.50mm	BLACK PVC	KK	NO	10M	80Kg	
45 x 2.50 MESH - GREEN PVC								
C240 045 250 PG KK	2400mm	45x2.50mm	GREEN PVC	KK	NO	10M	57Kg	
C300 045 250 PG KK	3000mm	45x2.50mm	GREEN PVC	KK	NO	10M	71Kg	
C360 045 250 PG KK	3600mm	45x2.50mm	GREEN PVC	KK	NO	10M	80Kg	

Chainwire 45 x 3.15 Mesh - Tennis Court Applications - Complies with AS1725: 2010

CODE	HEIGHT	MESH	FINISH	SELVEDGE	STOCK	STD ROLL	ROLL KG	PRICE/M
45 x 3.15 MESH - HEAVY GALVANISED								
C240 045 315 GH KK	2400mm	45x3.15mm	HEAVY GAL	KK	NO	10M	53Kg	
C300 045 315 GH KK	3000mm	45x3.15mm	HEAVY GAL	KK	NO	10M	97Kg	
C360 045 315 GH KK	3600mm	45x3.15mm	HEAVY GAL	KK	NO	10M	115Kg	
45 x 3.15 MESH - BLACK PVC								
C240 045 315 PB KK	2400mm	45x3.15mm	BLACK PVC	KK	NO	10M	85Kg	
C300 045 315 PB KK	3000mm	45x3.15mm	BLACK PVC	KK	NO	10M	101.5Kg	
C360 045 315 PB KK	3600mm	45x3.15mm	BLACK PVC	KK	NO	10M	122Kg	
45 x 3.15 MESH - GREEN PVC								
C240 045 315 PG KK	2400mm	45x3.15mm	GREEN PVC	KK	NO	10M	85Kg	
C300 045 315 PG KK	3000mm	45x3.15mm	GREEN PVC	KK	NO	10M	101.5Kg	
C360 045 315 PG KK	3600mm	45x3.15mm	GREEN PVC	KK	NO	10M	122Kg	

NOTE: \$45 CUTTING FEE APPLIES FOR CUT ROLLS

- Chainwire marked "YES" in the stock column is subject to peak demand & may not ALWAYS be available.
- Non stock items are made to order and are subject to minimum order quantities & extended lead times.
- Contact Protective Fencing for availability of other combinations of wire types and diameters. Minimum order quantities & extended lead times may apply.

Discounts Available for Bulk Quantities

www.profence.com.au

Chainwire 40 x 2.50 Mesh - Industrial Safety Enclosures

CODE	HEIGHT	MESH	FINISH	SELVEDGE	STOCK	STD ROLL	ROLL KG	PRICE/M
------	--------	------	--------	----------	-------	----------	---------	---------

40 x 2.50 MESH - HEAVY GALVANISED

C240 040 250 GH KK	2400mm	40x2.50mm	HEAVY GAL	KK	NO	10M	50Kg	
C300 040 250 GH KK	3000mm	40x2.50mm	HEAVY GAL	KK	NO	10M	62Kg	
C360 040 250 GH KK	3600mm	40x2.50mm	HEAVY GAL	KK	NO	10M	73Kg	

40 x 2.50 MESH - BLACK PVC

C240 040 250 PB KK	2400mm	40x2.50mm	BLACK PVC	KK	NO	10M	60Kg	
C300 040 250 PB KK	3000mm	40x2.50mm	BLACK PVC	KK	NO	10M	75Kg	
C360 040 250 PB KK	3600mm	40x2.50mm	BLACK PVC	KK	NO	10M	83Kg	

40 x 2.50 MESH - GREEN PVC

C240 040 250 PG KK	2400mm	40x2.50mm	GREEN PVC	KK	NO	10M	60Kg	
C300 040 250 PG KK	3000mm	40x2.50mm	GREEN PVC	KK	NO	10M	75Kg	
C360 040 250 PG KK	3600mm	40x2.50mm	GREEN PVC	KK	NO	10M	83Kg	

Chainwire 40 x 3.15 Mesh - Industrial Safety Enclosures

CODE	HEIGHT	MESH	FINISH	SELVEDGE	STOCK	STD ROLL	ROLL KG	PRICE/M
------	--------	------	--------	----------	-------	----------	---------	---------

40 x 3.15 MESH - HEAVY GALVANISED

C240 040 315 GH KK	2400mm	40x3.15mm	HEAVY GAL	KK	NO	10M	78Kg	
C300 040 315 GH KK	3000mm	40x3.15mm	HEAVY GAL	KK	NO	10M	97Kg	
C360 040 315 GH KK	3600mm	40x3.15mm	HEAVY GAL	KK	NO	10M	115Kg	

40 x 3.15 MESH - BLACK PVC

C240 040 315 PB KK	2400mm	40x3.15mm	BLACK PVC	KK	NO	10M	92Kg	
C300 040 315 PB KK	3000mm	40x3.15mm	BLACK PVC	KK	NO	10M	113Kg	
C360 040 315 PB KK	3600mm	40x3.15mm	BLACK PVC	KK	NO	10M	137Kg	

40 x 3.15 MESH - GREEN PVC

C240 040 315 PG KK	2400mm	40x3.15mm	GREEN PVC	KK	NO	10M	92Kg	
C300 040 315 PG KK	3000mm	40x3.15mm	GREEN PVC	KK	NO	10M	113Kg	
C360 040 315 PG KK	3600mm	40x3.15mm	GREEN PVC	KK	NO	10M	137Kg	



TYPICAL SECURITY CHAINWIRE FENCE APPLICATION



TYPICAL CHAINWIRE ENCLOSURE

Chainwire 30 x 2.50 Mesh - Golf and Security Screen Applications

CODE	HEIGHT	MESH	FINISH	SELVEDGE	STOCK	STD ROLL	ROLL KG	PRICE/M
30 x 2.50 MESH - HEAVY GALVANISED								
C180 030 250 GH KK	1800mm	30x2.50mm	HEAVY GAL	KK	NO	10M	46Kg	
C240 030 250 GH KK	2400mm	30x2.50mm	HEAVY GAL	KK	NO	10M	62Kg	
C300 030 250 GH KK	3000mm	30x2.50mm	HEAVY GAL	KK	NO	10M	77Kg	
C360 030 250 GH KK	3600mm	30x2.50mm	HEAVY GAL	KK	NO	10M	95.5Kg	
30 x 2.50 MESH - BLACK PVC								
C180 030 250 PB KK	1800mm	30x2.50mm	BLACK PVC	KK	NO	10M	57Kg	
C240 030 250 PB KK	2400mm	30x2.50mm	BLACK PVC	KK	NO	10M	76Kg	
C300 030 250 PB KK	3000mm	30x2.50mm	BLACK PVC	KK	NO	10M	95Kg	
C360 030 250 PB KK	3600mm	30x2.50mm	BLACK PVC	KK	NO	10M	114Kg	
30 x 2.50 MESH - GREEN PVC								
C180 030 250 PG KK	1800mm	30x2.50mm	GREEN PVC	KK	NO	10M	57Kg	
C240 030 250 PG KK	2400mm	30x2.50mm	GREEN PVC	KK	NO	10M	76Kg	
C300 030 250 PG KK	3000mm	30x2.50mm	GREEN PVC	KK	NO	10M	95Kg	
C360 030 250 PG KK	3600mm	30x2.50mm	GREEN PVC	KK	NO	10M	114Kg	

Chainwire 25 x 2.50 Mesh - Golf and Security Screen Applications - Only Available in KK Selvedge

CODE	HEIGHT	MESH	FINISH	SELVEDGE	STOCK	STD ROLL	ROLL KG	PRICE/M
25 x 2.50 MESH - HEAVY GALVANISED								
C090 025 250 GH KK	900mm	25x2.50mm	HEAVY GAL	KK	NO	10M	30Kg	
C180 025 250 GH KK	1800mm	25x2.50mm	HEAVY GAL	KK	NO	10M	62Kg	
C210 025 250 GH KK	2100mm	25x2.50mm	HEAVY GAL	KK	NO	10M	Kg	
25 x 2.50 MESH - BLACK PVC								
C090 025 250 PB KK	900mm	25x2.50mm	HEAVY GAL	KK	NO	10M	30Kg	
C180 025 250 PB KK	1800mm	25x2.50mm	HEAVY GAL	KK	NO	10M	62Kg	
C210 025 250 PB KK	2100mm	25x2.50mm	HEAVY GAL	KK	NO	10M	Kg	

NOTE: \$45 CUTTING FEE APPLIES FOR CUT ROLLS

- Chainwire marked "YES" in the stock column is subject to peak demand & may not ALWAYS be available.
- Non stock items are made to order and are subject to minimum order quantities & extended lead times.
- Contact Protective Fencing for availability of other combinations of wire types and diameters. Minimum order quantities & extended lead times may apply.

Discounts Available for Bulk Quantities

www.profence.com.au

PREMIUM FUSION BONDED CHAINWIRE MESH - Extreme Environments

Fusion bonded wire is a premium product offering superior performance in extreme environments.

The special PVC coating is bonded to the galvanised wire core using a primary adhesive creating an extremely durable wire with:-

- Outstanding and long lasting adhesion in humid environments
- Superior corrosion resistance - less creeping rust.
- High impact resistance - highly suitable for sporting applications.
- Smooth, attractive coating surface.
- High dimensional tolerances.

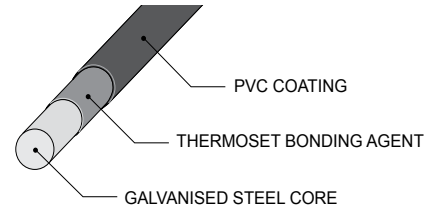

CODE	HEIGHT	MESH	FINISH	SELVEDGE	STOCK	STD ROLL	ROLL KG	PRICE/M
CHAINWIRE 49 x 2.50 MESH - FUSION BONDED PVC - BLACK								
C120 049 250 FBB KK	1200mm	49x2.50mm	FUSION BLACK	KK	NO	15M	34.5Kg	
C180 049 250 FBB KK	1800mm	49x2.50mm	FUSION BLACK	KK	NO	10M	34Kg	
C300 049 250 FBB KK	3000mm	49x2.50mm	FUSION BLACK	KK	NO	10M	58Kg	
C360 049 250 FBB KK	3600mm	49x2.50mm	FUSION BLACK	KK	NO	10M	70Kg	

CHAINWIRE 45 x 2.50 MESH - FUSION BONDED PVC - BLACK								
C120 045 250 FBB KK	1200mm	45x2.50mm	FUSION BLACK	KK	NO	15M	43Kg	
C180 045 250 FBB KK	1800mm	45x2.50mm	FUSION BLACK	KK	NO	10M	34Kg	
C300 045 250 FBB KK	3000mm	45x2.50mm	FUSION BLACK	KK	NO	10M	71Kg	
C360 045 250 FBB KK	3600mm	45x2.50mm	FUSION BLACK	KK	NO	10M	79Kg	

CHAINWIRE 45 x 3.15 MESH - FUSION BONDED PVC - BLACK								
C120 045 315 FBB KK	1200mm	45x3.15mm	FUSION BLACK	KK	NO	15M	45Kg	
C180 045 315 FBB KK	1800mm	45x3.15mm	FUSION BLACK	KK	NO	10M	45Kg	
C300 045 315 FBB KK	3000mm	45x3.15mm	FUSION BLACK	KK	NO	10M	80Kg	
C360 045 315 FBB KK	3600mm	45x3.15mm	FUSION BLACK	KK	NO	10M	89Kg	



TENNIS COURT AT SEA CLIFF - DOVER HEIGHTS SYDNEY



BASE BALL COURT - MELBOURNE

Pipe - Stock Lengths - Complies to AS1074

CODE	PIPE	LENGTH	GRADE	WEIGHT	SLING	SLING KG	STOCK	PRICE	P/COAT
X LIGHT - GREEN END -									
PIPE 25NB 65 XL	25NB	6500mm	X LIGHT	10.53Kg	91	958.3Kg	YES		
PIPE 25NB 72 XL	25NB	7200mm	X LIGHT	11.67Kg	91	1062Kg	YES		
PIPE 32NB 65 XL	32NB	6500mm	X LIGHT	13.46Kg	61	821.1Kg	YES		
PIPE 32NB 72 XL	32NB	7200mm	X LIGHT	14.9Kg	61	909Kg	YES		
PIPE 40NB 65 XL	40NB	6500mm	X LIGHT	17.55Kg	61	1070.6Kg	YES		
PIPE 40NB 72 XL	40NB	7200mm	X LIGHT	19.44Kg	61	1186Kg	YES		
PIPE 50NB 65 XL	50NB	6500mm	X LIGHT	22.1Kg	37	817.7Kg	YES		
PIPE 50NB 72 XL	50NB	7200mm	X LIGHT	24.48Kg	37	905.8Kg	YES		
PIPE 80NB 65 XL	80NB	6500mm	X LIGHT	37.05Kg	19	704Kg	YES		

LIGHT - YELLOW END

PIPE 25NB 65 GLPE	25NB	6500mm	LIGHT	13.36Kg	91	1215.8Kg	YES		
PIPE 32NB 65 GLPE	32NB	6500mm	LIGHT	17.1Kg	61	1043.1Kg	YES		
PIPE 40NB 65 GLPE	40NB	6500mm	LIGHT	21.65Kg	61	1320.7Kg	YES		
PIPE 50NB 65 GLPE	50NB	6500mm	LIGHT	27.37Kg	37	1012.7Kg	YES		
PIPE 80NB 65 GLPE	80NB	6500mm	LIGHT	45Kg	19	855Kg	YES		

MEDIUM - BLUE END

PIPE 25NB 65 GMPE	25NB	6500mm	MEDIUM	16.06Kg	91	1461.5Kg	YES		
PIPE 32NB 65 GMPE	32NB	6500mm	MEDIUM	20.67Kg	61	1260.9Kg	YES		
PIPE 40NB 65 GMPE	40NB	6500mm	MEDIUM	23.73Kg	61	1447.6Kg	YES		
PIPE 50NB 65 GMPE	50NB	6500mm	MEDIUM	33.41Kg	37	1236.2Kg	YES		
PIPE 80NB 65 GMPE	80NB	6500mm	MEDIUM	55.45Kg	19	1053.6Kg	YES		
PIPE 100NB 65 GMPE	100NB	6500mm	MEDIUM	80.6Kg	19	1531.5Kg	NO		



Pipe Specifications

NOMINAL BORE	OUTSIDE DIAMETER	350 GRADE (AS1074)	250 GRADE (AS1074)	250 GRADE (AS1074)
		X LIGHT (GREEN END)	LIGHT (YELLOW END)	MEDIUM (BLUE END)
20mm (3/4")	26.9mm (1 1/16")	2.0mm WALL	2.3mm WALL	2.6mm WALL
25mm (1")	33.7mm (1 11/32")	2.0mm WALL	2.6mm WALL	3.2mm WALL
32mm (1 1/4")	42.4mm (1 11/16")	2.0mm WALL	2.6mm WALL	3.2mm WALL
40mm (1 1/2")	48.3mm (1 29/32")	2.3mm WALL	2.9mm WALL	3.2mm WALL
50mm (2")	60.3mm (2 3/8")	2.3mm WALL	2.9mm WALL	3.6mm WALL
80mm (3")	88.9mm (3 1/2")	2.9mm WALL	3.2mm WALL	4.0mm WALL
100mm (4")	114.3mm (4 1/2")	-	4.5mm WALL	-

Security Post Dimensions

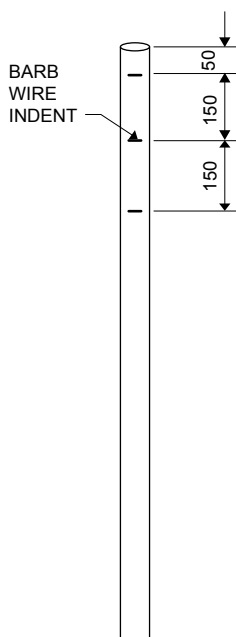

INTERMEDIATE/CORNER/GATE

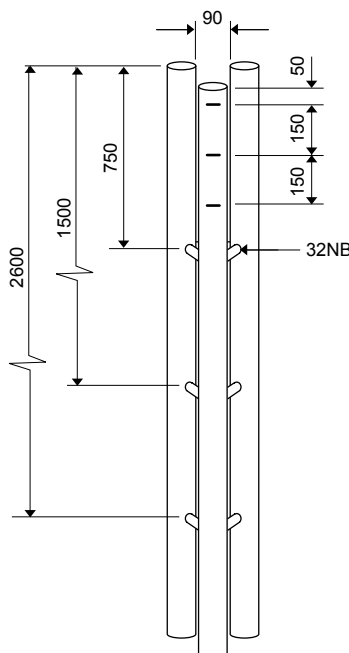

GATE - TRIPLE POST

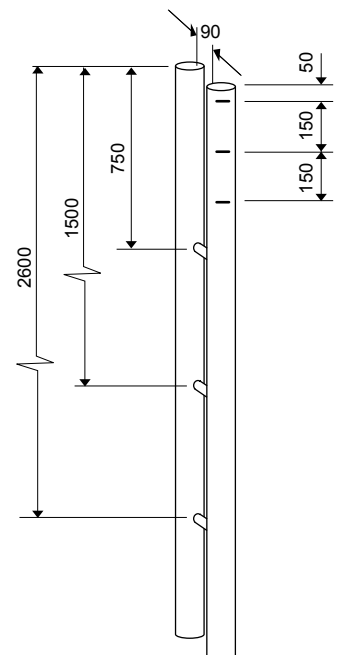

GATE - DOUBLE POST

CHAINWIRE POSTS

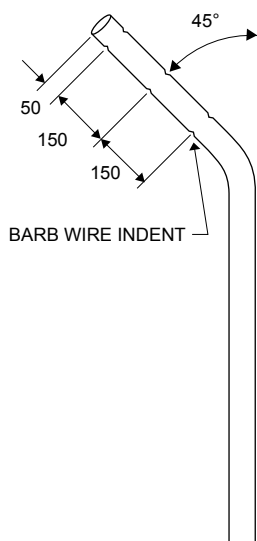

INTERMEDIATE CRANKED POSTS

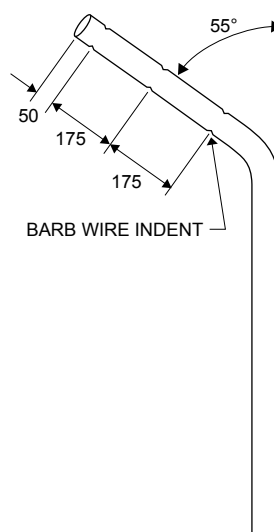

CORNER CRANKED POSTS

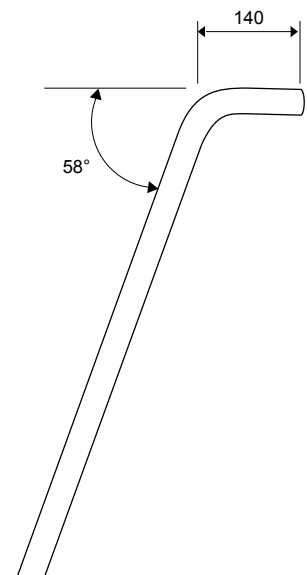

TYPICAL BACK STAY

Security Fencing Guide - 1800mm High Chainwire Fence with 3 Rows Barbed Wire

CODE	DESCRIPTION	PIPE	LENGTH	GRADE	STOCK	WEIGHT	PRICE
INTERMEDIATE POSTS - 3 x POST INDENTS FOR BARBED WIRE - COMPLIES TO AS1074							
PST SX 32NB 3B 3000	STRAIGHT	32NB	3000mm	X LIGHT	YES	6.30Kg	
PST BX 32NB 3B 3000	BENT (45°)	32NB	3000mm	X LIGHT	YES	6.30Kg	
PST SX 32NB 3B 3250	STRAIGHT	32NB	3250mm	X LIGHT	NO	6.73Kg	
PST BX 32NB 3B 3250	BENT (45°)	32NB	3250mm	X LIGHT	NO	6.73Kg	
PST SL 40NB 3B 3250	STRAIGHT	40NB	3250mm	LIGHT	NO	10.82Kg	
PST BL 40NB 3B 3250	BENT (45°)	40NB	3250mm	LIGHT	NO	10.82Kg	
PST SM 40NB 3B 3250	STRAIGHT	40NB	3250mm	MEDIUM	NO	11.87Kg	
PST BM 40NB 3B 3250	BENT (45°)	40NB	3250mm	MEDIUM	NO	11.87Kg	
PST BM 50NB 3B 3250	BENT (45°)	50NB	3250mm	MEDIUM	NO	16.71Kg	
CORNER & GATE POSTS - 3 x POST INDENTS FOR BARBED WIRE - COMPLIES TO AS1074							
PST SX 50NB 3B 3250	STRAIGHT	50NB	3250mm	X LIGHT	YES	11.05Kg	
PST BX 50NB 3B 3250A	BENT (55°)	50NB	3250mm	X LIGHT	YES	11.05Kg	
PST SL 50NB 3B 3250	STRAIGHT	50NB	3250mm	LIGHT	NO	13.69Kg	
PST BL 50NB 3B 3250A	BENT (55°)	50NB	3250mm	LIGHT	YES	13.69Kg	
PST SM 50NB 3B 3250	STRAIGHT	50NB	3250mm	MEDIUM	NO	16.71Kg	
PST BM 50NB 3B 3250A	BENT (55°)	50NB	3250mm	MEDIUM	NO	16.71Kg	
PST SL 80NB 3B 3250	STRAIGHT	80NB	3250mm	LIGHT	YES	22.49Kg	
PST SM 100NB 3B 3250	STRAIGHT	100NB	3250mm	MEDIUM	NO	40.30Kg	
PST SL2X80 3B 3250	STRAIGHT - TWIN	2 x 80NB	3250mm	LIGHT	YES	46.37Kg	
PST SL3X80 3B 3250	STRAIGHT - TRIPLE	3 x 80NB	3250mm	LIGHT	YES	74.35Kg	
STAYS - COMPLIES TO AS1074							
STY XL 25NB 2130 B	BACK STAY - BENT	25NB	2130mm	X LIGHT	NO	3.46Kg	
STY XL 32NB 3600	STRAIGHT	32NB	3600mm	X LIGHT	YES	7.46Kg	

Security Fencing Guide - 2100mm High Chainwire Fence with 3 Rows Barbed Wire

CODE	DESCRIPTION	PIPE	LENGTH	GRADE	STOCK	WEIGHT	PRICE
INTERMEDIATE POSTS - 3 x POST INDENTS FOR BARBED WIRE - COMPLIES TO AS1074							
PST SX 32NB 3B 3250	STRAIGHT	32NB	3250	X LIGHT	NO	6.73Kg	
PST BX 32NB 3B 3250	BENT (45°)	32NB	3250	X LIGHT	NO	6.73Kg	
PST SL 40NB 3B 3250	STRAIGHT	40NB	3250	LIGHT	NO	10.82Kg	
PST BL 40NB 3B 3250	BENT (45°)	40NB	3250	LIGHT	NO	10.82Kg	
PST SM 40NB 3B 3250	STRAIGHT	40NB	3250	MEDIUM	NO	11.87Kg	
CORNER & GATE POSTS - 3 x POST INDENTS FOR BARBED WIRE - COMPLIES TO AS1074							
PST SX 50NB 3B 3500	STRAIGHT	50NB	3500	X LIGHT	NO	11.9Kg	
PST BX 50NB 3B 3500A	BENT (55°)	50NB	3500	X LIGHT	NO	11.9Kg	
PST SL 50NB 3B 3500	STRAIGHT	50NB	3500	LIGHT	NO	14.74Kg	
PST BL 50NB 3B 3500A	BENT (55°)	50NB	3500	LIGHT	NO	14.74Kg	
PST SM 50NB 3B 3500	STRAIGHT	50NB	3500	MEDIUM	NO	18.0Kg	
PST SL 80NB 3B 3500	STRAIGHT	80NB	3500	LIGHT	NO	24.22Kg	
PST BM 80NB 3B 3500	BENT (45°)	80NB	3500	LIGHT	NO	24.22Kg	
PST SM 100NB 3B 3500	STRAIGHT	100NB	3500	MEDIUM	NO	43.4Kg	
PST SL2X80NB 3B 3500	STRAIGHT - TWIN	2 x 80NB	3500	LIGHT	NO	51.46Kg	
PST SL3X80NB 3B 3500	STRAIGHT - TRIPLE	3 x 80NB	3500	LIGHT	NO	78.98Kg	
STAYS - COMPLIES TO AS1074							
STY XL 25NB 2130 B	BACK STAY - BENT	25NB	2130	X LIGHT	NO	3.46Kg	
STY XL 32NB 3600	STRAIGHT	32NB	3600	X LIGHT	YES	7.46Kg	

Domestic Fencing Guide

CODE	DESCRIPTION	PIPE	LENGTH	GRADE	STOCK	WEIGHT	PRICE
900mm HIGH CHAINWIRE FENCE - POST & STAYS COMPLY TO AS1074							
PST SX 32NB OB 1500	INTERMEDIATE POST	32NB	1500mm	X LIGHT	NO	3.11Kg	
PST SX 50NB OB 1600	CORNER/GATE POST	50NB	1600mm	X LIGHT	NO	5.44Kg	
STY XL 32NB 3250	STAY	32NB	3250mm	X LIGHT	NO	6.73Kg	
1200mm HIGH CHAINWIRE FENCE- POST & STAYS COMPLY TO AS1074							
PST SX 32NB OB 1800	INTERMEDIATE POST	32NB	1800mm	X LIGHT	NO	3.73Kg	
PST SX 50NB OB 1980	CORNER/GATE POST	50NB	1980mm	X LIGHT	NO	6.74Kg	
STY XL 32NB 3250	STAY	32NB	3250mm	X LIGHT	NO	6.73Kg	
1500mm HIGH CHAINWIRE FENCE - POST & STAYS COMPLY TO AS1074							
PST SX 32NB OB 2130	INTERMEDIATE POST	32NB	2130mm	X LIGHT	NO	4.48Kg	
PST SX 50NB OB 2300	CORNER/GATE POST	50NB	2300mm	X LIGHT	NO	7.82Kg	
STY XL 32NB 3250	STAY	32NB	3250mm	X LIGHT	NO	6.73Kg	
1800mm HIGH CHAINWIRE FENCE - POST & STAYS COMPLY TO AS1074							
PST SX 32NB OB 2400	INTERMEDIATE POST	32NB	2400mm	X LIGHT	YES	4.97Kg	
PST SX 50NB OB 2600	CORNER POST	50NB	2600mm	X LIGHT	YES	8.84Kg	
PST SX 80NB OB 2600	GATE POST	80NB	2600mm	X LIGHT	YES	14.82Kg	
PST SM 100NB OB 2600	GATE POST	100NB	2600mm	MEDIUM	NO	32.24Kg	
STY XL 32NB 3600	STAY	32NB	3600mm	X LIGHT	YES	7.46Kg	
STY XL 25NB 2130 B	BACK STAY - BENT	25NB	2130mm	X LIGHT	NO	3.45Kg	
2100mm HIGH CHAINWIRE FENCE - POST & STAYS COMPLY TO AS1074							
PST SX 32NB OB 2700	INTERMEDIATE POST	32NB	2700mm	X LIGHT	NO	5.59Kg	
PST SX 50NB OB 3000	CORNER POST	50NB	3000mm	X LIGHT	YES	10.2Kg	
PST SX 80NB OB 3250	GATE POST	80NB	3250mm	X LIGHT	YES	17.1Kg	
PST SM 100NB OB 3250	GATE POST	100NB	3250mm	MEDIUM	NO	37.20Kg	
STY XL 32NB 3600	STAY	32NB	3600mm	X LIGHT	YES	7.46Kg	
STY XL 25NB 2130 B	BACK STAY - BENT	25NB	2130mm	X LIGHT	NO	3.45Kg	

CHAINWIRE POSTS

NON STANDARD POSTS AND STAYS CAN BE SUPPLIED TO CUSTOMERS'S REQUIREMENTS - POA

Discounts Available for Bulk Quantities

www.profence.com.au

Tennis Court Guide

CODE	DESCRIPTION	PIPE	LENGTH	GRADE	STOCK	WEIGHT	PRICE
3000mm HIGH CHAINWIRE COURT- POST & STAYS COMPLY TO AS1074							
PST SL 40NB OB 3600	INTERMEDIATE POST	40NB	3600mm	LIGHT	NO	11.99Kg	
PST SL 40NB OB 1800	INTERMEDIATE POST	40NB	1800mm	LIGHT	NO	6.0Kg	
PST SL 80NB OB 3900	CORNER POST	80NB	3900mm	LIGHT	NO	26.99Kg	
PIPE 32NB 65 GLPE	RAIL	32NB	6500mm	LIGHT	YES	17.1Kg	
PIPE S BEND 32NB GL 7200	RAIL 'S' BEND	32NB	7200mm	LIGHT	NO	18.94Kg	
STY GL 40NB 4800	CORNER STAY	40NB	4800mm	LIGHT	YES	15.99Kg	
GSD GL 40NB 3600	GATE SURROUND	40NB	3600mm	LIGHT	YES	11.99Kg	
PST SGL 80NB 1980	NET POST X 2	80NB	1980mm	LIGHT	NO	13.7Kg	
PST 90NB 795	NET POST SOCKET	90NB	795mm	LIGHT	NO	6.32Kg	

3600mm HIGH CHAINWIRE COURT- POST & STAYS COMPLY TO AS1074

PST SL 40NB OB 4500	INTERMEDIATE POST	40NB	4500mm	LIGHT	NO	14.99Kg	
PST SL 40NB OB 1800	INTERMEDIATE POST	40NB	1800mm	LIGHT	NO	6.0Kg	
PST SX 80NB OB 4500	CORNER POST	80NB	4500mm	LIGHT	NO	31.14Kg	
PIPE 32NB 65 GLPE	RAIL	32NB	6500mm	LIGHT	YES	17.1Kg	
PIPE S BEND 32NB GL 7200	RAIL 'S' BEND	32NB	7200mm	LIGHT	NO	18.94Kg	
STY XL 40NB 5300	CORNER STAY	40NB	5300mm	LIGHT	YES	17.65Kg	
GSD GL 40NB 3600	GATE SURROUND	40NB	3600mm	LIGHT	YES	11.99Kg	
PST SGL 80NB 2000	NET POST X 2	80NB	2000mm	LIGHT	NO	13.7Kg	
PST 90NB 795	NET POST SOCKET	90NB	795mm	LIGHT	NO	6.32Kg	

Standard 3M High 34M x 17M Tennis Court Fence Kit - Top Rail only - 2 x Single Gates

COMPONENTS	QUANTITY
Chainwire - 3000 49x2.5 Heavy Gal KK	110M
Cable Wire - 3.15 Heavy Gal - 25Kg	2 Coils
Lacing Wire - 1.57 Heavy Gal - 25Kg	2 Coils
Corner Post - 3900x80NB LIGHT	4
Intermediate Post - 3600x40NB LIGHT	32
Top Rail - 6500x32NB LIGHT	18
Gate Surround - 3600x40NB LIGHT	2

COMPONENTS	QUANTITY
Gate Frame - 1980x1070 25NB LIGHT	2
Post Clamp - UFFT80	4
Rail Clamp - UFFB32	8
Tee Clamp - T4040	2
Tee Clamp - T3240	32
Gate Hinge - H4025	4
Post Cap - K80	4

Cricket Net Guide - 3000mm High Chainwire Net - Posts and Stays Comply to AS1074

CODE	DESCRIPTION	PIPE	LENGTH	GRADE	STOCK	WEIGHT	PRICE
PST SL 40NB OB 3600	INTERMEDIATE	40NB	3600mm	LIGHT	NO	11.99Kg	
PST SL 50NB OB 3900	CORNER POST	50NB	3900mm	LIGHT	NO	16.42Kg	
PST SL 80NB OB 3900	CORNER POST	80NB	3900mm	LIGHT	NO	26.99Kg	
PIPE 32NB 65 GLPE	RAIL	32NB	6500mm	LIGHT	YES	17.1Kg	

Discounts Available for Bulk Quantities

www.profence.com.au

DOMESTIC GATES - 900~1200mm HIGH

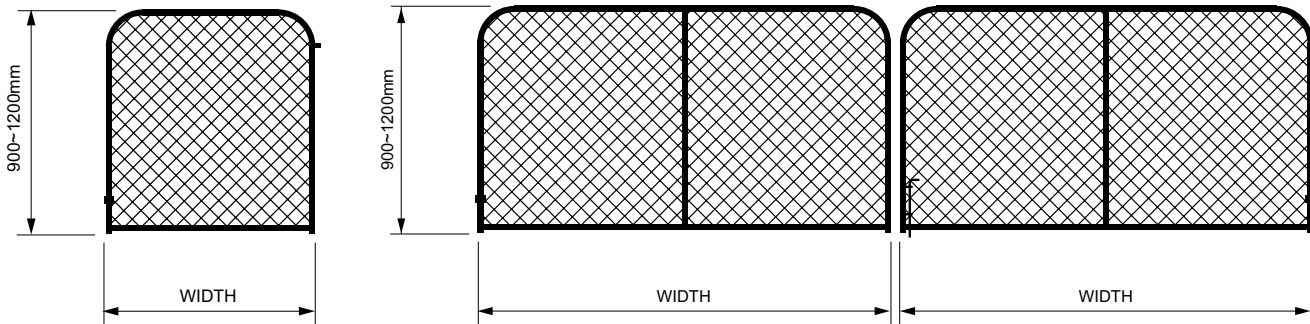

Gate Specifications

Frame: 25NB Light - Hinge Collar Fitted
 Chainwire: 50 x 2.50/3.15mm Chainwire Mesh
 Lacing Wire: Ø2.0mm

Single Gate: 1 x D' Latch & Striker
 Double Gate: 1 x Gate Bow, 1 x Screw on Drop Bolt
 Note: Hinges NOT Included

Domestic Gates - 900~1200mm High

CODE	TYPE	GATE HEIGHT	GATE WIDTH	FRAME	MESH	FINISH	WEIGHT	STOCK	PRICE
GS16G	SINGLE	900mm	900mm	25NB	50 x 2.5/3.15mm	ALL GALVANISED	11Kg	NO	
GS16FC	SINGLE	900mm	900mm	25NB	50 x 2.5/3.15mm	FULL COLOUR	11.5Kg	NO	
GD18G	DOUBLE	900mm	3000mm (2 x 1500mm)	25NB	50 x 2.5/3.15mm	ALL GALVANISED	32Kg	NO	
GD18FC	DOUBLE	900mm	3000mm (2 x 1500mm)	25NB	50 x 2.5/3.15mm	FULL COLOUR	33.3Kg	NO	
GS22G	SINGLE	1200mm	900mm	25NB	50 x 2.5/3.15mm	ALL GALVANISED	13Kg	NO	
GS22FC	SINGLE	1200mm	900mm	25NB	50 x 2.5/3.15mm	FULL COLOUR	13.6Kg	NO	
GD24G	DOUBLE	1200mm	3000mm (2 x 1500mm)	25NB	50 x 2.5/3.15mm	ALL GALVANISED	42Kg	NO	
GD24FC	DOUBLE	1200mm	3000mm (2 x 1500mm)	25NB	50 x 2.5/3.15mm	FULL COLOUR	43.7Kg	NO	

- Please specify: Left or Right hand opening - 2.50mm or 3.15mm mesh
- All gate dimensions are actual

Discounts Available for Bulk Quantities

www.profence.com.au

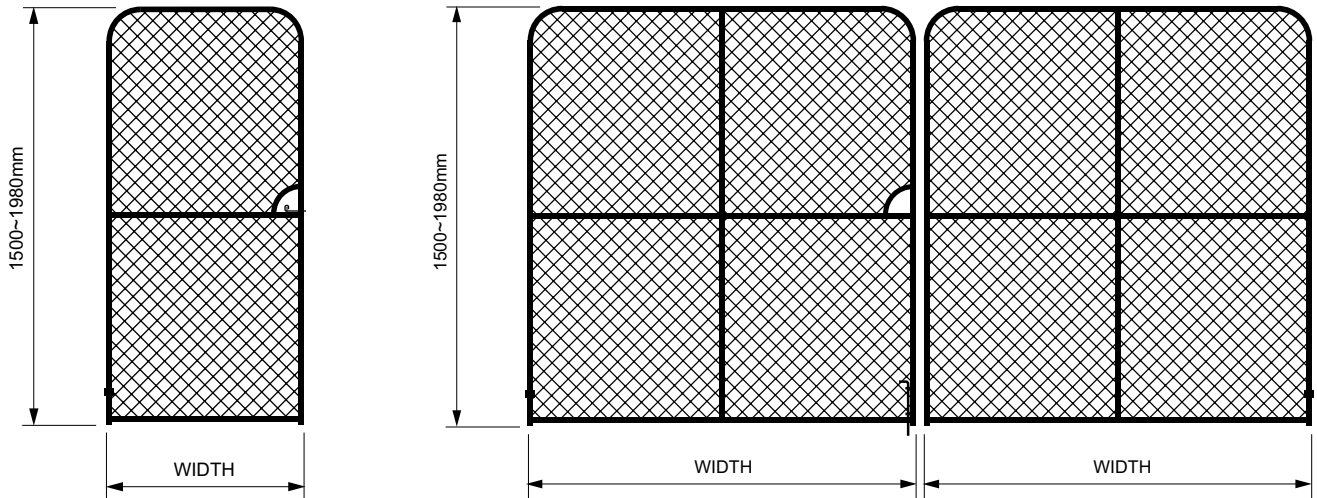
ROUND TOP GATES - 1500~1980mm HIGH

Gate Specifications

Frame: 25NB Light - Hinge Collar Fitted
 Chainwire: General - 50 x 2.50/3.15mm Mesh
 Tennis Court - 49x2.50mm Mesh
 Lacing Wire: Ø2.0mm

Single Gate: 1 x Shoot Bolt, 1 x Hand Hole
 Double Gate: 1 x 8mm Chain, 1 x Hand Hole
 1 x Screw on Drop Bolt
 Note: Hinges NOT Included

Round Top Gates -1500~1980mm High

CODE	TYPE	GATE HEIGHT	GATE WIDTH	FRAME	MESH	FINISH	WEIGHT	STOCK	PRICE
GS28G	SINGLE	1500mm	900mm	25NB	50 x 2.5mm	ALL GALVANISED	20Kg	NO	
GS28FC	SINGLE	1500mm	900mm	25NB	50 x 2.5mm	FULL COLOUR	20.8Kg	NO	
GD31G	DOUBLE	1500mm	3000mm (2 x 1500mm)	25NB	50 x 2.5/3.15mm	ALL GALVANISED	61Kg	NO	
GD31FC	DOUBLE	1500mm	3000mm (2 x 1500mm)	25NB	50 x 2.5/3.15mm	FULL COLOUR	63.5Kg	NO	
GS34G	SINGLE	1800mm	900mm	25NB	50 x 2.5mm	ALL GALVANISED	24Kg	YES (LH)	
GS34FC	SINGLE	1800mm	900mm	25NB	50 x 2.5mm	FULL COLOUR	24.9Kg	NO	
GD36G	DOUBLE	1800mm	3000mm (2 x 1500mm)	25NB	50 x 2.5/3.15mm	ALL GALVANISED	71Kg	NO	
GD36FC	DOUBLE	1800mm	3000mm (2 x 1500mm)	25NB	50 x 2.5/3.15mm	FULL COLOUR	7.4Kg	NO	
GD38G	DOUBLE	1800mm	4000mm (2 x 2000mm)	25NB	50 x 2.5/3.15mm	ALL GALVANISED	80Kg	NO	
GD38FC	DOUBLE	1800mm	4000mm (2 x 2000mm)	25NB	50 x 2.5/3.15mm	FULL COLOUR	83.2Kg	NO	
GD39G	DOUBLE	1800mm	6000mm (2 x 3000mm)	32NB	50 x 2.5/3.15mm	ALL GALVANISED	101Kg	NO	
GD39FC	DOUBLE	1800mm	6000mm (2 x 3000mm)	32NB	50 x 2.5/3.15mm	FULL COLOUR	105Kg	NO	

TENNIS COURT GATES

GS23DTFC	SINGLE	1230mm	1070mm	25NB	49 x 2.5mm	ALL GALVANISED	21Kg	NO	
GS40G	SINGLE	1980mm	1070mm	25NB	49 x 2.5mm	ALL GALVANISED	30Kg	YES (LH)	
GS40FC	SINGLE	1980mm	1070mm	25NB	49 x 2.5mm	FULL COLOUR	31.2Kg	YES (LH)	
GD40G	DOUBLE	1980mm	3000mm (2 x 1500mm)	25NB	49 x 2.5mm	ALL GALVANISED	73Kg	NO	
GD40FC	DOUBLE	1980mm	3000mm (2 x 1500mm)	25NB	49 x 2.5mm	FULL COLOUR	75.9Kg	NO	

- Please specify: Left or Right hand opening.
- Tennis Courts - Where available specify: 2.50mm or 3.15mm mesh.
- All gate dimensions are actual.
- Refer page 6-6 for Gate Surround.

Discounts Available for Bulk Quantities

SECURITY GATES - 1800mm HIGH

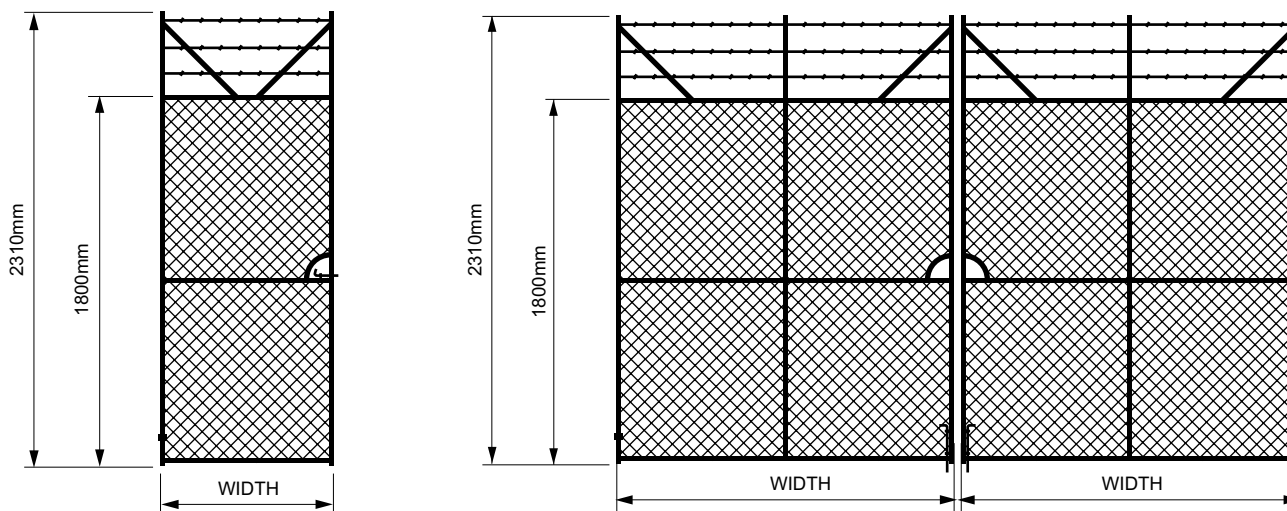

Gate Specifications

Frame:	25NB or 32NB Light - Hinge Collar Fitted	Single Gate:	1 x Shoot Bolt, 1 x Hand Hole, 2 Caps
Chainwire:	50 x 2.50/3.15mm Chainwire Mesh	Double Gate:	2 x 8mm Heavy Gal Chain, 2 x Hand Holes,
Lacing Wire:	Ø2.0mm Heavy Galvanised		2 x Drop Bolts (welded), 6 x Caps
Barbed Wire:	1.57mm Gauge Hi Tensile	Note:	Hinges NOT Included

Economy Gates - 1800mm High + 3 Rows Barbed Wire (2310mm Overall Height)

CODE	TYPE	GATE WIDTH	FRAME	MESH	FINISH	WEIGHT	STOCK	PRICE
GS1GE	SINGLE	900mm	25NB	50 x 2.5mm	ALL GALVANISED	30Kg	YES (LH)	
GS1FCE	SINGLE	900mm	25NB	50 x 2.5mm	FULL COLOUR	31.2Kg	YES (LH)	
GD7GE	DOUBLE	3000mm (2 x 1500)	25NB	50 x 2.5mm	ALL GALVANISED	84Kg	YES	
GD7FCE	DOUBLE	3000mm (2 x 1500)	25NB	50 x 2.5mm	FULL COLOUR	87.4Kg	NO	
GD9GE	DOUBLE	4000mm (2 x 2000)	25NB	50 x 2.5mm	ALL GALVANISED	111Kg	NO	
GD9FCE	DOUBLE	4000mm (2 x 2000)	25NB	50 x 2.5mm	FULL COLOUR	115.4Kg	NO	
GD12GE	DOUBLE	6000mm (2 x 3000)	32NB	50 x 2.5mm	ALL GALVANISED	154Kg	YES	
GD12FCE	DOUBLE	6000mm (2 x 3000)	32NB	50 x 2.5mm	FULL COLOUR	160.2Kg	YES	
GD14GE	DOUBLE	8000mm (2 x 4000)	32NB	50 x 2.5mm	ALL GALVANISED	217Kg	NO	
GD14FCE	DOUBLE	8000mm (2 x 4000)	32NB	50 x 2.5mm	FULL COLOUR	225.7Kg	NO	

• All gate dimensions are actual - Gates without extension also available POA

Premium Gates - 1800mm High + 3 Rows Barbed Wire (2310mm Overall Height)

CODE	TYPE	GATE WIDTH	FRAME	MESH	FINISH	WEIGHT	STOCK	PRICE
GS1GP	SINGLE	900mm	32NB	50 x 3.15mm	ALL GALVANISED	35Kg	YES (LH)	
GS1FCP	SINGLE	900mm	32NB	50 x 3.15mm	FULL COLOUR	36.4Kg	YES (LH)	
GD7GP	DOUBLE	3000mm (2 x 1500)	32NB	50 x 3.15mm	ALL GALVANISED	84Kg	YES	
GD7FCP	DOUBLE	3000mm (2 x 1500)	32NB	50 x 3.15mm	FULL COLOUR	87.4Kg	NO	
GD9GP	DOUBLE	4000mm (2 x 2000)	32NB	50 x 3.15mm	ALL GALVANISED	111Kg	NO	
GD9FCP	DOUBLE	4000mm (2 x 2000)	32NB	50 x 3.15mm	FULL COLOUR	115.4Kg	NO	
GD12GP	DOUBLE	6000mm (2 x 3000)	32NB	50 x 3.15mm	ALL GALVANISED	154Kg	YES	
GD12FCP	DOUBLE	6000mm (2 x 3000)	32NB	50 x 3.15mm	FULL COLOUR	160.2Kg	NO	
GD14GP	DOUBLE	8000mm (2 x 4000)	32NB	50 x 3.15mm	ALL GALVANISED	217Kg	NO	
GD14FCP	DOUBLE	8000mm (2 x 4000)	32NB	50 x 3.15mm	FULL COLOUR	225.7Kg	NO	

• All gate dimensions are actual - Gates without extension also available POA

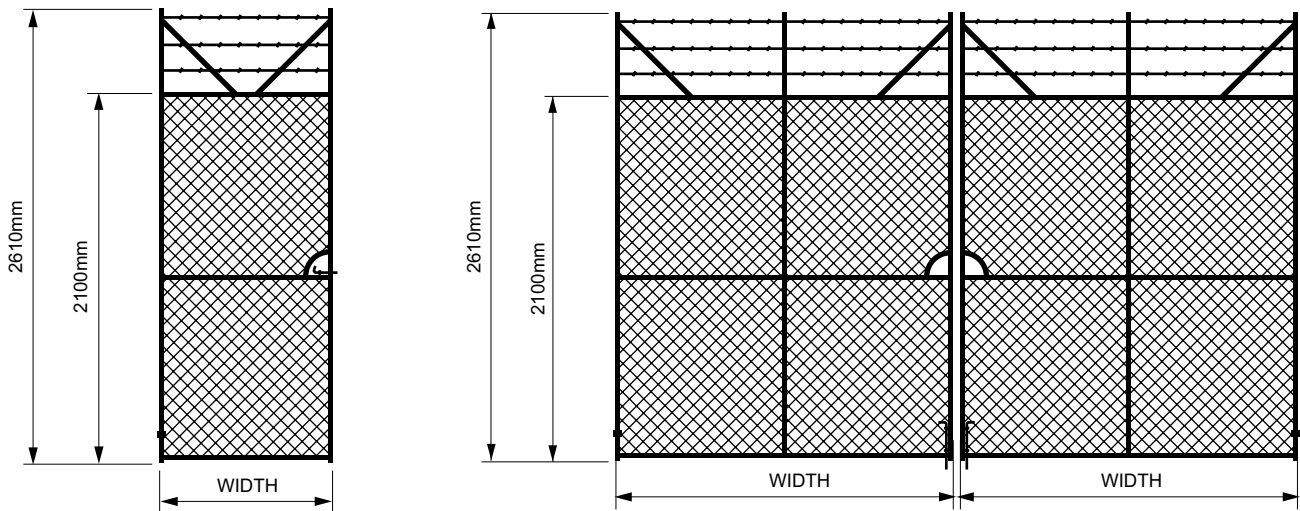
SECURITY GATES - 2100mm HIGH

Gate Specifications

Frame: 25NB or 32NB Light - Hinge Collar Fitted
 Chainwire: 50 x 2.50/3.15mm Chainwire Mesh
 Lacing Wire: Ø2.0mm Heavy Galvanised
 Barbed Wire: 1.57mm Gauge Hi Tensile

Single Gate: 1 x Shoot Bolt, 1 x Hand Hole, 2 Caps
 Double Gate: 2 x 8mm Heavy Gal Chain, 2 x Hand Holes, 2 x Drop Bolts (welded), 6 x Caps

Note: Hinges NOT Included

Economy Gates - 2100mm High + 3 Rows Barbed Wire (2610mm Overall Height)

CODE	TYPE	GATE WIDTH	FRAME	MESH	FINISH	WEIGHT	STOCK	PRICE
GS49GE	SINGLE	900mm	25NB	50 x 2.5mm	ALL GALVANISED	23Kg	YES (LH)	
GS49FCE	SINGLE	900mm	25NB	50 x 2.5mm	FULL COLOUR	23.9Kg	YES (LH)	
GD50GE	DOUBLE	3000mm (2 x 1500)	25NB	50 x 2.5mm	ALL GALVANISED	61Kg	YES	
GD50FCE	DOUBLE	3000mm (2 x 1500)	25NB	50 x 2.5mm	FULL COLOUR	63.4Kg	NO	
GD51GE	DOUBLE	4000mm (2 x 2000)	25NB	50 x 2.5mm	ALL GALVANISED	80Kg	NO	
GD51FCE	DOUBLE	4000mm (2 x 2000)	25NB	50 x 2.5mm	FULL COLOUR	83.2Kg	NO	
GD52GE	DOUBLE	6000mm (2 x 3000)	32NB	50 x 2.5mm	ALL GALVANISED	116Kg	YES	
GD52FCE	DOUBLE	6000mm (2 x 3000)	32NB	50 x 2.5mm	FULL COLOUR	120.6Kg	YES	
GD53GE	DOUBLE	8000mm (2 x 4000)	32NB	50 x 2.5mm	ALL GALVANISED	162Kg	NO	
GD53FCE	DOUBLE	8000mm (2 x 4000)	32NB	50 x 2.5mm	FULL COLOUR	168.5Kg	NO	

• All gate dimensions are actual - Gates without extension also available POA

Premium Gates - 2100mm High + 3 Rows Barbed Wire (2610mm Overall Height)

CODE	TYPE	GATE WIDTH	FRAME	MESH	FINISH	WEIGHT	STOCK	PRICE
GS49GP	SINGLE	900mm	32NB	50 x 3.15mm	ALL GALVANISED	45Kg	YES (LH)	
GS49FCP	SINGLE	900mm	32NB	50 x 3.15mm	FULL COLOUR	46.8Kg	YES (LH)	
GD50GP	DOUBLE	3000mm (2 x 1500)	32NB	50 x 3.15mm	ALL GALVANISED	106Kg	YES	
GD50FCP	DOUBLE	3000mm (2 x 1500)	32NB	50 x 3.15mm	FULL COLOUR	110.3Kg	NO	
GD51GP	DOUBLE	4000mm (2 x 2000)	32NB	50 x 3.15mm	ALL GALVANISED	118Kg	NO	
GD51FCP	DOUBLE	4000mm (2 x 2000)	32NB	50 x 3.15mm	FULL COLOUR	122.7Kg	NO	
GD52GP	DOUBLE	6000mm (2 x 3000)	32NB	50 x 3.15mm	ALL GALVANISED	151Kg	YES	
GD52FCP	DOUBLE	6000mm (2 x 3000)	32NB	50 x 3.15mm	FULL COLOUR	157Kg	YES	
GD53GP	DOUBLE	8000mm (2 x 4000)	32NB	50 x 3.15mm	ALL GALVANISED	212Kg	NO	
GD53FCP	DOUBLE	8000mm (2 x 4000)	32NB	50 x 3.15mm	FULL COLOUR	220Kg	NO	

• All gate dimensions are actual - Gates without extension also available POA

Cable Wire

CODE	SIZE	WEIGHT	COIL	FINISH	STOCK	PRICE
2.5mm CABLE WIRE						
WIRE CABLE 250 GH25KG	2.5mm	25kg	625M	HEAVY GAL	YES	
WIRE CABLE 250 PB25KG	2.5mm	25kg	500M	PVC - BLACK	YES	
WIRE CABLE 250 PG25KG	2.5mm	25kg	500M	PVC - GREEN	YES	
WIRE CABLE 250 FB25KG	2.5mm	25kg	500M	FUSION - BLACK	YES	

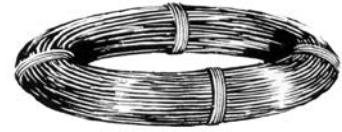

NOTE: CABLE WIRE ALSO AVAILABLE IN 1 TONNE STEMS - POA

3.15mm CABLE WIRE

WIRE CABLE 315 GH10KG	3.15mm	10kg	160M	HEAVY GAL	YES	
WIRE CABLE 315 GH25KG	3.15mm	25kg	400M	HEAVY GAL	YES	
WIRE CABLE 315 PB10KG	3.15mm	10kg	140M	PVC - BLACK	YES	
WIRE CABLE 315 PB25KG	3.15mm	25kg	350M	PVC - BLACK	YES	
WIRE CABLE 315 PG10KG	3.15mm	10kg	140M	PVC - GREEN	YES	
WIRE CABLE 315 PG25KG	3.15mm	25kg	350M	PVC - GREEN	YES	
WIRE CABLE 315 FBB25KG	3.15mm	25kg	350M	FUSION - BLACK	YES	

4.0mm HELICOIL

HELICOIL 4 GH25KG	4.0mm	25kg	250M	HEAVY GAL	YES	
HELICOIL 4 PB25KG	4.0mm	25kg	225M	PVC - BLACK	YES	

Tie Wire

CODE	SIZE	WEIGHT	COIL	FINISH	STOCK	PRICE
WIRE TIE 157 GH5KG	1.57 mm	5 kg	300M	HEAVY GAL	YES	
WIRE TIE 157 PB5KG	1.57 mm	5 kg	285M	PVC - BLACK	YES	
WIRE TIE 157 PG5KG	1.57 mm	5 kg	285M	PVC - GREEN	YES	
WIRE TIE 200 GH5KG	2.0 mm	5 kg	200M	HEAVY GAL	YES	
WIRE TIE 200 PB5KG	2.0 mm	5 kg	160M	PVC - BLACK	YES	



NOTE: TIE WIRE ALSO AVAILABLE IN STEMS POA

Barbed Wire Coils

CODE	SIZE	TYPE	COIL	WEIGHT	STOCK	PRICE
WIRE BARB 157 HT 500M	1.57mm	HI TENSILE	500M	23.5Kg	YES	
WIRE BARB 157 HT 100M	1.57mm	HI TENSILE	100M	5Kg	YES	
WIRE BARB 250 GH	2.50mm	IOWA SOFT	400M	45Kg	NO	
WIRE BARB 200 SS	2.0mm	316 S/S	200M	18Kg	NO	



NEW: STAINLESS STEEL NOW AVAILABLE - POA

Razor Tape - Core Wire to AS1472, AS4534

CODE	LOOP	BARB	FIXING	EXT. LGTH	WEIGHT	STOCK	PRICE
CONCERTINA SHORT BARB TAPE - 56 LOOPS - GAL CORE WIRE - 3 CLIPS							
PRT SB 56 550C3	Ø550mm	GAL	300mm CTRS	8.4M	9.75Kg	YES	
FLAT LOOP SHORT BARB TAPE - 45 LOOPS - GAL CORE WIRE							
PRT SB 45 550F	Ø550mm	GAL	275mm	13M@50%	7.75Kg	YES	
CONCERTINA LONG BARB TAPE - 56 LOOPS - GAL CORE WIRE - 3 CLIPS							
PRT LB 566 760C3	Ø760mm	S/S	300mm	8.4M	13.89Kg	NO	

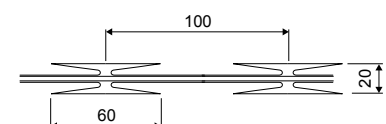
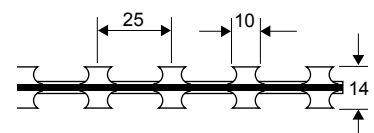

• Other sizes and finishes available. Contact Protective Fencing

Easy-Ty Security Ties

CODE	DESCRIPTION	STOCK	PRICE
EASYTY32	Ø3.8mm WIRE TIE TO SUIT 32NB PIPE	YES	
EASYTY40	Ø3.8mm WIRE TIE TO SUIT 40NB PIPE	YES	
EASYTY50	Ø3.8mm WIRE TIE TO SUIT 50NB PIPE	YES	
EASYTY65	Ø3.8mm WIRE TIE TO SUIT 65NB PIPE	YES	
EASYTY80	Ø3.8mm WIRE TIE TO SUIT 80NB PIPE	YES	
EASYTY100	Ø3.8mm WIRE TIE TO SUIT 100NB PIPE	YES	
EASYTYTOOL	TOOL TO SUIT ALL TIE SIZES	YES	

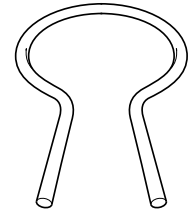

Bag Ties - Stainless Steel

CODE	SIZE	PACK	KG/1000	FINISH	STOCK	PRICE/EA
DRT16	Ø1.6x150mm	1000	4.2	STAINLESS STEEL	YES	

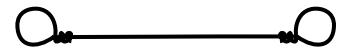

Maspro Rings & Hand Tool

CODE	RING	PACK	QTY	FINISH	STOCK	PRICE
MASPRO 200 GH 1 KG	2.00mm	1Kg	1000	HEAVY GALVANISED	YES	
MASPRO 200 PB 1 KG	2.00mm	1Kg	650	PVC COATED - BLACK	YES	
MASPRO 200 PG 1 KG	2.00mm	1Kg	650	PVC COATED - GREEN	YES	
DNETTING PLIER	MASPRO CLIP PLIERS - SINGLE RING USE				YES	

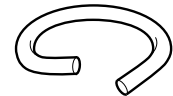

Discounts Available for Bulk Quantities

www.profence.com.au

HIGH SECURITY FITTINGS & ACCESSORIES

Bulldog Spike Razor Top - Galvanised

CODE	DESCRIPTION	WEIGHT	STOCK	PRICE	P/COAT
PBRT	H50xW110mm SPIKE - 800mm LONG	1.1Kg	YES		

- Curved base suitable for round pipe or any flat surface.
- Interlocking predrilled sections to create a continuous effective deterrent.



Mesh Joiners - Suit Ø5mm Mesh Sheets - Galvanised

CODE	DESCRIPTION	WEIGHT	STOCK	PRICE
PHJ24H	TYPE 1 H JOINER- 2400mm LONG	7.3Kg	NO	
PCJ24H	TERMINATION - 2400mm LONG	6.3Kg	NO	

- Comply with the requirements of Ausgrid substation specifications
- Longer lengths available upon request

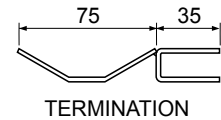
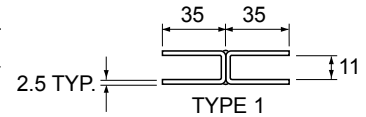

Concertina Razor Tape Support Mesh - Galvanised

CODE	DESCRIPTION	WEIGHT	STOCK	PRICE
PM RWS	'V' SUPPORT 358 MESH - 2400mm LONG	3.0Kg	NO	
PM EARWS	'V' SUPPORT EA MESH - 2400mm LONG	2.4Kg	NO	

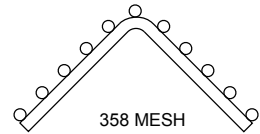
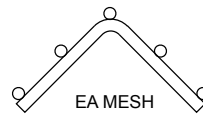

FASTENERS

Anti Tamper Screws - Irius Drive

CODE	DIA.	MAX DRILL	ETL	LENGTH	CTN	KG/100	STOCK	PRCE/100
PSD8/8	5.5mm	8mm	8mm	25mm	250	0.54	YES	
PSD14/12	5.5mm	14mm	12mm	32mm	250	0.69	YES	

ETL = EFFECTIVE THREAD LENGTH MAX DRILL = MAXIMUM DRILL CAPACITY

PE420	IRIUS DRIVE TOOL	YES	EA
-------	------------------	-----	----

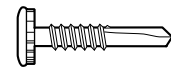

Self Drilling Screws - Hexagon Head - Galvanised

CODE	GAUGE.	TPI	LENGTH	CTN	KG/100	STOCK	PRICE/100
DTEK121420	12mm	14	20mm	500	0.5	YES	

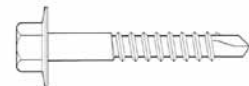

Cup Head Bolts & Nuts - Galvanised

CODE	SIZE	LENGTH	KG/100	STOCK	PRICE/100
PM830G	M8	30mm	1.52	YES	
PM840G	M8	40mm	1.9	YES	
DH08090G	M8	90mm	4.6	YES	
DH08150G	M8	150mm	7.6	YES	

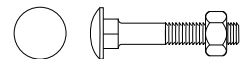

FASTENERS

T Bolt - Suit 'W' Palisade Pales - Galvanised

CODE	SIZE	KG/100	STOCK	PRICE/100
PP TB825G	M8X25	1.15	YES	

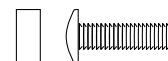

Shear Nuts - Galvanised

CODE	SIZE	KG/100	STOCK	PRICE/100
PSNM8G	M8	1.3	YES	
PSNM12G	M12	2.7	YES	



Washers- Galvanised

CODE	SIZE	KG/100	STOCK	PRICE/100
DWG8MM	M8	0.29	YES	
DWG10MM	M10	0.42	YES	
DWG12MM	M12	0.7	YES	
DWG16MM	M16	1.38	NO	

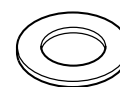

Promax 358 Mesh Fixing Clips - 2mm Galvanised Steel

DESCRIPTION	KG/100	STOCK	PRICE/100
PFCG SUIT M8 CUP HEAD BOLT - 2 WIRE COVER	1.1	YES	

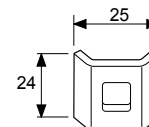

Wire Panel & Razor Tape Clips - Galvanised

CODE	DESCRIPTION	FINISH	KG/100	STOCK	PRICE
DUC8/10G	25mm 'U' PANEL CLIP - Ø8 HOLE	HDG	0.9	YES	
DUC19G	19mm 'U' PANEL CLIP - Ø8 HOLE	HDG	0.74	YES	
PRUC	CONCERTINA RAZOR TAPE CLIP - GALVABOND		1.1	YES	



DUC8/10G

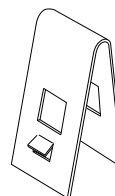

PRUC

WITH
ANTI-TWIST
LOCK

Discounts Available for Bulk Quantities

www.profence.com.au

UNI-FIT CHAINWIRE FENCING AND RAILING SYSTEM

Different fittings are made by connecting a cup and ring together using supplied bolt and tightening with a 6mm Allen Key (55NM). Rails are secured to the fitting with grub screws with the option of adding a security screw. All fittings include a tap security plug for grub screw.

- Versatile multi-adjustable system.
- Raking up to 80°
- AS 1657/1992, AS/NZS 1170.1/2002 compliant.
- Reduced stock holdings.
- No welding.
- No accurate pre-site measuring required.
- 2 year warranty.

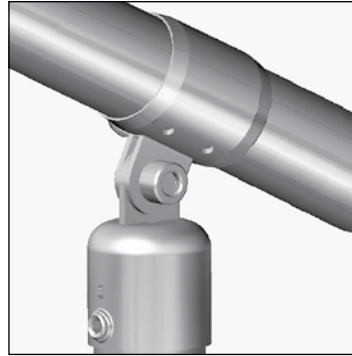

Uni-Fit Fittings - Hot Dip Galvanised

CODE	DESCRIPTION	PIPE	CARTON	KG/ITEM	STOCK	GAL PRICE
------	-------------	------	--------	---------	-------	-----------

CUP + BOLT

UNCP25	POST/RAIL END CUP	25NB	124	0.15	YES	
UNCP32	POST/RAIL END CUP	32NB	100	0.21	YES	
UNCP40	POST/RAIL END CUP	40NB	96	0.23	YES	
UNCP50	POST/RAIL END CUP	50NB	72	0.37	YES	
UNCP80	POST/RAIL END CUP	80NB	36	0.5	NO	



1 WAY RING

UN1R25	ADJUST. 1 WAY FITTING	25NB	144	0.17	YES	
UN1R32	ADJUST. 1 WAY FITTING	32NB	96	0.22	YES	
UN1R40	ADJUST. 1 WAY FITTING	40NB	80	0.23	YES	
UN1R50	ADJUST. 1 WAY FITTING	50NB	52	0.30	NO	
UN1R80	ADJUST. 1 WAY FITTING	80NB	28	0.39	NO	



2 WAY RING

UN2R32	ADJUST. 2 WAY FITTING	32NB	72	0.20	YES	
UN2R40	ADJUST. 2 WAY FITTING	40NB	72	0.27	YES	
UN2R50	ADJUST. 2 WAY FITTING	50NB	40	0.30	YES	
UN2R80	ADJUST. 2 WAY FITTING	80NB	28	0.50	YES	



2 WAY SPLIT RING - CUPS NOT INCLUDED

UFSR2-40	ADJUSTABLE OFFSET	40NB	48	0.36	NO	
----------	-------------------	------	----	------	----	--

Used on middle rail when raking up stairs

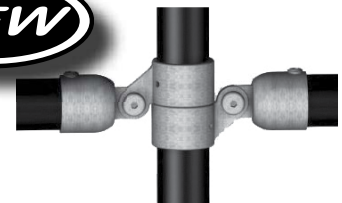

2 WAY 90° RING

UN2R32	ADJUST. 2 WAY FITTING	32NB	72	-	YES	
UN2R40	ADJUST. 2 WAY FITTING	40NB	72	0.27	YES	
UN2R50	ADJUST. 2 WAY FITTING	50NB	40	0.35	YES	
UN2R80	ADJUST. 2 WAY FITTING	80NB	28	-	YES	



Note: All Uni-Fit fittings come with tap-in steel security plugs for grub screws

Uni-Fit Fittings - Hot Dip Galvanised

CODE	DESCRIPTION	PIPE	CARTON	KG/ITEM	STOCK	GAL PRICE
------	-------------	------	--------	---------	-------	-----------

4 WAY RING

UN4R32	ADJUST. 4 WAY FITTING	32NB	60	0.28	NO	
UN4R40	ADJUST. 4 WAY FITTING	40NB	36	0.35	NO	
UN4R50	ADJUST. 4 WAY FITTING	50NB	24	0.55	NO	



UNIVERSAL RAIL PLATE

UFPR	SCREW ON RAIL PLATE	32,40,50NB	248	0.09	YES	
------	---------------------	------------	-----	------	-----	--



STRAIGHT JOINER

UFJ180-25	INTERNAL JOIN	25NB	-	0.32	NO	
UFJ180-32	INTERNAL JOIN	32NB	-	0.43	NO	
UFJ180-40	INTERNAL JOIN	40NB	-	0.53	NO	
UFJ180-50	INTERNAL JOIN	50NB	-	0.70	NO	



ANGLE RAIL JOINER

UFJ90-25	90° RAIL JOINING ELBOW	25NB	-	0.32	NO	
UFJ90-32	90° RAIL JOINING ELBOW	32NB	-	0.44	NO	
UFJ90-40	90° RAIL JOINING ELBOW	40NB	-	0.68	NO	
UFJ90-50	90° RAIL JOINING ELBOW	50NB	-	0.76	NO	



UFJ127-25	127° RAIL JOINING ELBOW	25NB	-		NO	
UFJ127-32	127° RAIL JOINING ELBOW	32NB	-	0.44	NO	
UFJ127-40	127° RAIL JOINING ELBOW	40NB	-	0.68	NO	
UFJ127-50	127° RAIL JOINING ELBOW	50NB	-		NO	

HAND RAIL BRACKET

UFWB	SUITS 32NB, 40NB, 50NB RAILS		48	0.38	YES	
------	------------------------------	--	----	------	-----	--



KICK PLATE BRACKET

UNKP40	KICK RAIL BRACKET	40NB	40	0.32	NO	
--------	-------------------	------	----	------	----	--



Note: All Uni-Fit fittings include tap in steel security plugs to cover grub screws.

FITTINGS

Discounts Available for Bulk Quantities

www.profence.com.au

Two Part Interlock Hinges with Attachment - Galvanised

CODE	POST	GATE	CARTON	KG/ITEM	STOCK	PRICE
DTH4025	40NB	25NB	32	0.27	YES	
DTH4032	40NB	32NB	32	0.75	YES	
DTH5025	50NB	25NB	32	0.63	YES	
DTH5032	50NB	32NB	32	0.78	YES	
DTH6525	65NB	25NB	24	0.91	YES	
DSH8025	80NB	25NB	24	0.88	YES	
DSH8032	80NB	32NB	24	0.92	YES	
DSH8040	80NB	40NB	24	0.96	YES	
DSH10025	100NB	25NB	24	1.0	YES	
DSH10032	100NB	32NB	24	0.96	YES	
DSH10040	100NB	40NB	24	1.08	YES	

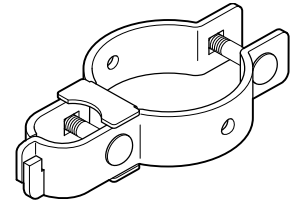

POWDER COATING SERVICE AVAILABLE

2 Part Hinges with Attachment - Galvanised

CODE	POST	GATE	CARTON	KG/ITEM	STOCK	PRICE
DGH3225	32NB	25NB	40	0.44	YES	
DGH4020	40NB	20NB	40	0.44	NO	

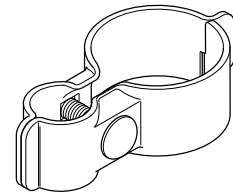

Adjustable Corners - Galvanised

CODE	BUTT	THRU	CARTON	KG/ITEM	STOCK	PRICE
DAC2525	25NB	25NB	30	0.57	NO	
DAC2532	25NB	32NB	30	0.64	NO	
DAC2540	25NB	40NB	30	0.7	NO	
DAC2550	25NB	50NB	20	0.8	NO	
DAC3232	32NB	32NB	20	0.85	NO	
DAC3240	32NB	40NB	16	0.88	NO	
DAC3250	32NB	50NB	16	0.88	NO	
DAC4040	40NB	40NB	16	0.94	NO	
DAC4050	40NB	50NB	16	0.94	NO	
DAC5050	50NB	50NB	12	1.25	NO	

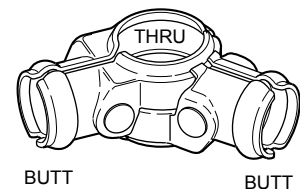

POWDER COATING SERVICE AVAILABLE

Adjustable Rail Tee - Galvanised

CODE	RAIL	POST	CARTON	KG/ITEM	STOCK	PRICE
DART2525	25NB	25NB	30	0.8	YES	
DART2532	25NB	32NB	30	0.84	YES	
DART2540	25NB	40NB	20	1.1	YES	

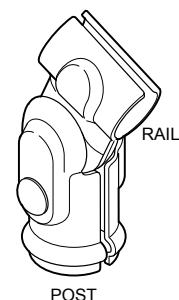

POWDER COATING SERVICE AVAILABLE

Universal Clamp Fittings - Galvanised

CODE	DESCRIPTION	PIPE	CARTON	KG/ITEM	STOCK	PRICE
RAIL CLAMPS						
DUFFB25	RAIL CLAMP	25NB	40	0.35	YES	
DUFFB32	RAIL CLAMP	32NB	30	0.4	YES	
DUFFB40	RAIL CLAMP	40NB	30	0.47	YES	
DUFFB50	RAIL CLAMP	50NB	20	0.55	YES	
POST CLAMPS						
DUFFT25	POST CLAMP	25NB	50	0.18	YES	
DUFFT32	POST CLAMP	32NB	40	0.23	YES	
DUFFT40	POST CLAMP	40NB	40	0.23	YES	
DUFFT50	POST CLAMP	50NB	40	0.25	YES	
DUFFT65	POST CLAMP	65NB	30	0.3	YES	
DUFFT80	POST CLAMP	80NB	20	0.35	YES	
DUFFT100	POST CLAMP	100NB	20	0.45	YES	
MULTI PURPOSE POST/RAIL CLAMP CONNECTOR						
DUFFMPC	MULTI-PURPOSE CONNECTOR		100	0.05	YES	

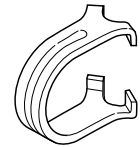
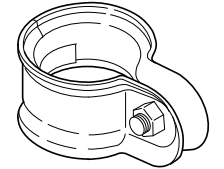
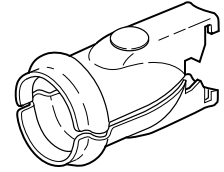

POWDER COATING SERVICE AVAILABLE

Fixed Tee Clamps - Galvanised

CODE	THRU	BUTT	CARTON	KG/ITEM	STOCK	PRICE
DT2525	25NB	25NB	50	0.23	YES	
DT2532	25NB	32NB	40	0.35	YES	
DT2540	25NB	40NB	30	0.5	YES	
DT3225	32NB	25NB	40	0.5	YES	
DT3232	32NB	32NB	40	0.4	YES	
DT3240	32NB	40NB	20	0.55	YES	
DT3250	32NB	50NB	20	0.8	YES	
DT4025	40NB	25NB	40	0.38	YES	
DT4032	40NB	32NB	30	0.48	YES	
DT4040	40NB	40NB	20	0.55	YES	
DT4050	40NB	50NB	10	0.9	YES	
DT5025	50NB	25NB	30	0.43	YES	
DT5032	50NB	32NB	30	0.54	YES	
DT5040	50NB	40NB	20	0.8	YES	
DT5050	50NB	50NB	10	0.95	YES	
DT8025	80NB	25NB	10	0.6	YES	
DT8032	80NB	32NB	10	0.95	YES	
DT8040	80NB	40NB	10	1.05	YES	
DT8050	80NB	50NB	10	1.3	YES	

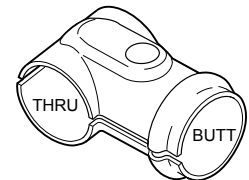

POWDER COATING SERVICE AVAILABLE

FITTINGS

Discounts Available for Bulk Quantities

www.profence.com.au

Fixed Cross - Galvanised

CODE	BUTT	THRU	CARTON	KG/ITEM	STOCK	PRICE
DX2525	25NB	25NB	30	0.45	YES	
DX2532	25NB	32NB	20	0.57	YES	
DX2540	25NB	40NB	30	0.54	YES	
DX2550	25NB	50NB	20	0.6	YES	
DX3232	32NB	32NB	20	0.67	YES	
DX3240	32NB	40NB	20	0.57	YES	
DX3250	32NB	50NB	10	0.94	YES	
DX4040	40NB	40NB	20	0.7	YES	
DX4050	40NB	50NB	10	0.55	YES	
DX5050	50NB	50NB	10	0.9	YES	

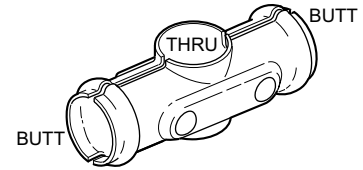

POWDER COATING SERVICE AVAILABLE - ADDITIONAL CHARGE \$3.20 PER FITTING

Fixed Corners - Galvanised

CODE	BUTT	THRU	CARTON	KG/ITEM	STOCK	PRICE
DC2525	25NB	25NB	30	0.45	YES	
DC2532	25NB	32NB	20	0.64	YES	
DC2540	25NB	40NB	20	0.54	YES	
DC2550	25NB	50NB	20	0.6	YES	
DC3232	32NB	32NB	20	0.6	YES	
DC3240	32NB	40NB	10	0.8	YES	
DC3250	32NB	50NB	10	1.1	YES	
DC4040	40NB	40NB	10	1.0	YES	
DC4050	40NB	50NB	10	1.1	YES	
DC5050	50NB	50NB	5	1.8	YES	

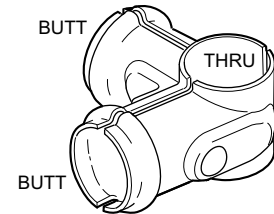

POWDER COATING SERVICE AVAILABLE - ADDITIONAL CHARGE \$3.20 PER FITTING

Post Caps

CODE	PIPE	FINISH	CARTON	KG/ITEM	STOCK	PRICE
ROUND POST CAP						
DK25	25NB	GALVANISED	150	0.052	YES	
DK32	32NB	GALVANISED	100	0.074	YES	
DK40	40NB	GALVANISED	80	0.085	YES	
DK50	50NB	GALVANISED	50	0.024	YES	
DK80	80NB	GALVANISED	20	0.225	YES	
DK100	100NB	GALVANISED	20	0.325	YES	

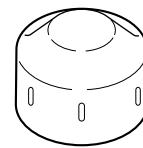

SQUARE TUBE CAP

DK50MSGB	50x50	GALVABOND	100	0.054	YES	
----------	-------	-----------	-----	-------	-----	--

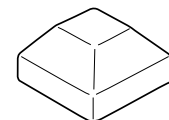

Discounts Available for Bulk Quantities

www.profence.com.au

Flanges - Galvanised

CODE	SIZE	PIPE	CARTON	KG/ITEM	STOCK	PRICE
OVAL FLANGES						
DF25	108x61x4mm	25NB	100	0.134	YES	
DF32	123x75x5mm	32NB	50	0.229	YES	
DF40	128x81x5mm	40NB	30	0.25	YES	
DF50	145x98x5mm	50NB	30	0.35	YES	
SQUARE FLANGES						
DF32H	100x100x5mm	32NB	30	0.40	YES	
DF40H	100x100x5mm	40NB	30	0.375	YES	
DF50H	130x130x5mm	50NB	20	0.64	YES	
SQUARE FLANGE PLATE						
DF130SP	130x130x5mm	-	20	0.64	YES	

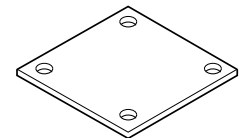
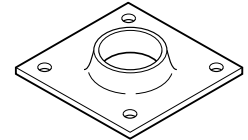
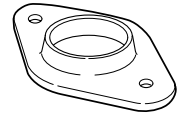

Temporary Fence Clamp - Galvanised

CODE	SIZE	CENTRES	CARTON	KG/ITEM	STOCK	PRICE
DTFCN2525	25NB x 25NB	71mm	50	0.25	NO	
DTFCN3232	32NB x 32NB	80mm	20	0.31	NO	
DTFCN4040	40NB x 40NB	85mm	20	0.645	NO	
DTFCN5050	50NB x 50NB	104mm	20	0.77	NO	

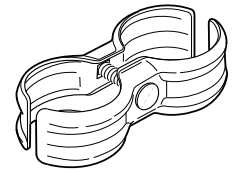

Post & Rail Joiners - Internal - 200mm - Galvanised

CODE	PIPE	CARTON	KG/ITEM	STOCK	PRICE
DSS25	25NB XL, GL	44	0.32	NO	
DSS32	32NB XL, GL	50	0.43	NO	
DSS40	40NB XL, GL	25	0.53	YES	
DSS50	50NB XL, GL	25	0.70	NO	

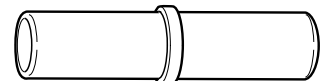

Security Rail Bracket & Sleeve - Galvanised

CODE	TYPE	TUBE	CARTON	KG/ITEM	STOCK	PRICE
DSRB620-92	BRACKET	40x40mm	50	0.25	NO	
DCUSMS	COVER SLEEVE	40x40mm	200	0.117	NO	

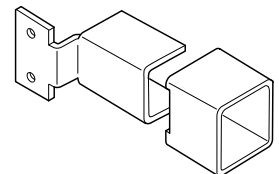

Bolt-on 'D' Latch & Striker - Galvanised

CODE	TYPE	CARTON	KG/ITEM	STOCK	PRICE
DCAC29	LATCH	50	0.217	YES	
DBTS28R	STRIKER	50	0.167	YES	

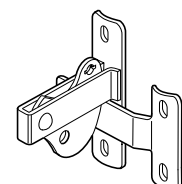

Pipe Hinge Straps & Attachments - Galvanised

CODE	TYPE	PIPE/SUIT	CARTON	KG/ITEM	STOCK	PRICE
------	------	-----------	--------	---------	-------	-------

HINGE STRAPS

DS3	STRAP HINGE	25NB	30	0.26	YES	
DS4	STRAP HINGE	32NB	30	0.32	YES	
DS5	STRAP HINGE	40NB	30	0.34	YES	
DS6	STRAP HINGE	50NB	30	0.34	YES	

ATTACHMENTS

DA3	ATTACHMENT	25NB	100	0.08	YES	
DA4	ATTACHMENT	32NB	100	0.1	YES	

BACKING PLATES

DBP3	BACKING PLATE	25NB	100	0.12	YES	
DBP4	BACKING PLATE	32NB	100	0.15	YES	

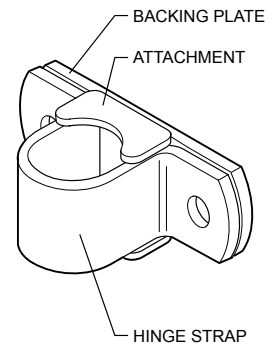

Drop Bolt & Lugs - Galvanised

CODE	DESCRIPTION	LENGTH	CARTON	KG/ITEM	STOCK	PRICE
------	-------------	--------	--------	---------	-------	-------

DB2	Ø16mm BOLT	370mm	20	0.72	NO	
DB3	Ø16mm BOLT	850mm	10	1.50	YES	
DL2	LUG / SUIT Ø16mm	-	200PRS	0.056	YES	



Security Drop Bolt - Galvanised

CODE	DESCRIPTION	LENGTH	CARTON	KG/ITEM	STOCK	PRICE
------	-------------	--------	--------	---------	-------	-------

DFPDB900	Ø16mm BOLT	900mm	5	2.0	NO	
DFPDBS1200	Ø16mm BOLT	1200mm	5	2.6	NO	
DL2	LUG / SUIT Ø16mm	-	200PRS	0.056	NO	

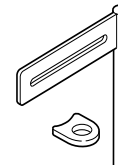

Drop Bolt & Slide Plate - Galvanised

CODE	LENGTH	CARTON	KG/ITEM	STOCK	PRICE
------	--------	--------	---------	-------	-------

DB15LG	400mm	20	0.53	YES	
--------	-------	----	------	-----	--

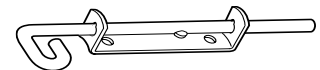

Shoot Bolt & Slide Plate - Zinc Plated

CODE	LENGTH	CARTON	KG/ITEM	STOCK	PRICE
------	--------	--------	---------	-------	-------

DB8	150mm	30	0.30	YES	
DB9	270mm	20	0.43	NO	

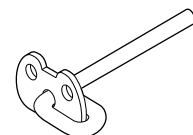

Double Gate Bow - Galvanised

CODE	GATE	CARTON	KG/ITEM	STOCK	PRICE
------	------	--------	---------	-------	-------

DCAC22	25NB	15	0.68	YES	
--------	------	----	------	-----	--

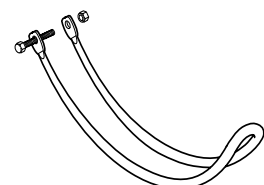

STEEL TUBULAR FENCING - SECURITY TUBE - POWDERCOATED - MADE TO ORDER

Specifications

Standards: AS 1926 1-1993
 Horizontal Rails: 40mm x 40mm RHS

Vertical Bars: 25mm x 25mm
 Gate Stiles: 65mm x 65mm RHS

DOUBLE WELD TOP AND BOTTOM

Included Fittings (only if posts purchased with panels and gates)

Standard Single Gate: 2 x Hinges, 1 x 'D' Latch and Striker
 Standard Double Gate: 4 x Hinges, 1 x 'D' Latch and Striker, 2 x Drop Bolts
 Panel: 4 x 'L' Brackets, 8 x 12-20 Tek Screws



Industrial Security Tube Fencing - 25 x 25mm Crimped Bars - Pre Galvanised - Powdercoated

DESCRIPTION	1800mm	2100mm
PANEL 2400mm WIDE		
PANEL 3000mm WIDE		
SINGLE GATE 980mm POST OPENING		
DOUBLE GATE 3000mm POST OPENING		

• Panel & gate fittings are an extra cost if **NO** posts are ordered

SECURITY TUBE FENCING TO SCHOOL SPECIFICATIONS AVAILABLE - POA

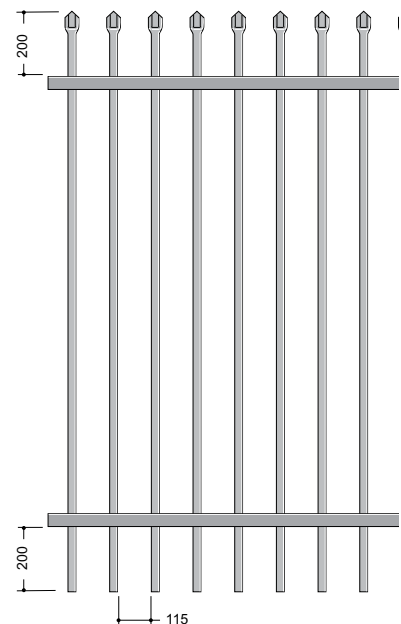

Steel Posts with Steel Cap - Powdercoated

SIZE	2400mm	2700mm	3000mm
50 x 50 x 1.6mm			
65 x 65 x 1.6mm			
75 x 75 x 1.6mm			
100 x 100 x 1.6mm			

• Panel & gate fittings are an extra cost if **NO** posts are ordered

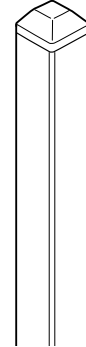

Optional Fittings

DESCRIPTION	PRICE
BRACKET 40x40mm CAST ALUMINIUM (POWDER COATED)	

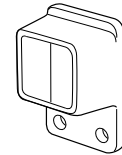

SECURITY RAIL BRACKET & SLEEVE 40x40mm (POWDER COATED)	
--	--

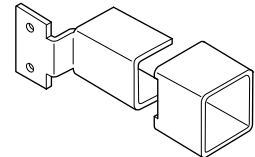

Security Tube Punched Rail - 40 x 40 x 1.6mm Tube - 25 x 25mm Hole - Galvabond

CODE	LENGTH	PUNCH	HOLES	WEIGHT	PRICE/EACH
GB PRS 4040 240	2400mm	SINGLE	17	4.3Kg	
GB PRD 4040 240	2400mm	DOUBLE	17	4.3Kg	
GB PRS 4040 300	3000mm	SINGLE	21	5.4Kg	
GB PRD 4040 300	3000mm	DOUBLE	21	5.4Kg	

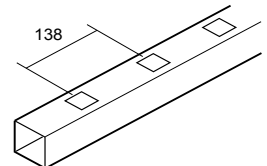

SOLD IN PACK QUANTITIES OF 10 ONLY

Security Tube Pickets - 25 x 25mm Tube - Crimped - Galvabond

CODE	LENGTH	WEIGHT	PRICE/EACH
GB SP 2525 180	1800mm	1.5Kg	
GB SP 2525 210	2100mm	1.8Kg	
GB SP 2525 240	2400mm	2.1Kg	



SOLD IN PACK QUANTITIES OF 10 ONLY

ALUMINIUM TUBULAR FENCING - SECURITY TUBE - POWDERCOATED - MADE TO ORDER

Specifications

Standards:	AS 1926 1-1993	Vertical Bars:	25mm x 25mm x 1.2mm
Horizontal Rails:	40mm x 40mm x 1.6mm		140mm Bar Centres

Security Tube Fencing - 25 x 25 x 1.2mm Crimped Bars - Aluminium - Powdercoated

DESCRIPTION	1800mm	2100mm
PANEL 2400mm WIDE - GLOSS BLACK		
PANEL 2400mm WIDE - HERITAGE GREEN		
• Other sizes and colours available - POA		
SINGLE GATE 980mm POST OPENING		
• 2 x bolt-on ball bearing hinges included.		
• Drop bolt and pad bolt with hand hole extra - refer below.		
DOUBLE GATE 3000mm POST OPENING		
• 1 x drop bolt, 4 x ball bearing hinges included.		
• Pad bolt with hand hole extra - refer below		

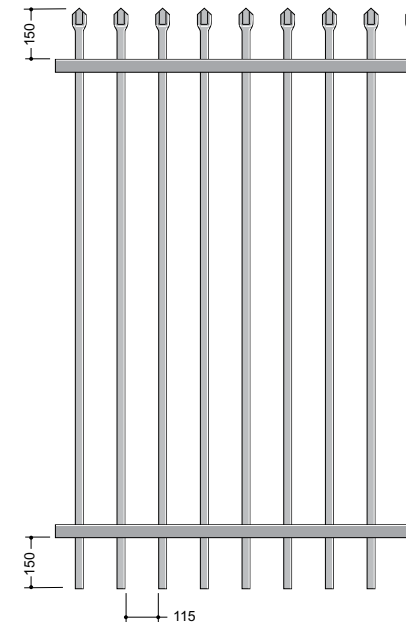

Aluminium Posts - Powdercoated

SIZE	2400mm	2700mm	3000mm
65 x 65 x 3mm			
100 x 100 x 3mm			
• Caps not included - refer below			

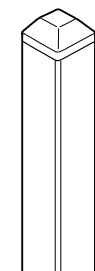

Fittings

DESCRIPTION	PRICE
BRACKET 40x40mm - CAST ALUMINIUM (POWDER COATED)	
65 x 65 STEEL CAP - GALVANISED POWDERCOATED	
100 x 100 STEEL CAP - GALVANISED POWDERCOATED	
DROP BOLT - GALVANISED POWDERCOATED	
PAD BOLT WITH HAND HOLE - GALVANISED POWDERCOATED	

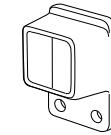

RMS PEDESTRIAN FENCE - NSW Roads & Maritime Services Specifications

Pedestrian fencing is designed to prevent pedestrians crossing the road at unsafe locations and guide them to safer crossing points. A pedestrian fence is not a safety barrier and it is not designed to exhibit the characteristics of a safety barrier.

The RMS (RTA) designed pedestrian fence comprises panels which are designed to collapse as a whole panel when impacted to minimise the detachment of individual elements. The fences also feature a staggered layout of the balusters allowing motorists and pedestrians approaching on opposite sides of the fence to see each other. There are 6 RMS approved designs for use as pedestrian barriers. The most common are types 1 & 5 which are available from Protective Fencing.



Pedestrian Fence - Hot Dip Galvanised (AS4680) & Powdercoated (AS4506)

CODE	DESCRIPTION	WEIGHT	P/COAT PRICE
RTAP1	TYPE 1 PEDESTRIAN PANEL - MEDIAN OR VERGE - 2M POST CENTRES	55Kg	
RTAP5	TYPE 5 PEDESTRIAN PANEL - MEDIAN OR VERGE - 2M POST CENTRES)	60Kg	
RTAIPG	INTERMEDIATE STANDARD POST - IN GROUND - POST CAP NOT INCLUDED	22Kg	
RTAIPF	INTERMEDIATE STANDARD POST - BASE PLATED - POST CAP NOT INCLUDED	27Kg	
RTAEPG	END POST - IN GROUND	30Kg	
RTAEPF	END POST - BASE PLATED	35Kg	
RTACBC	CROSS BREAK POST CAP - INCLUDES DOME NUTS AND BOOKER ROD	0.1Kg	
RTACIR	INFILL CIRCLES	1Kg	

Note: Pedestrian fence cannot be raked. Fence is stepped only.

Median = Middle of road. Verge = Kerb side.

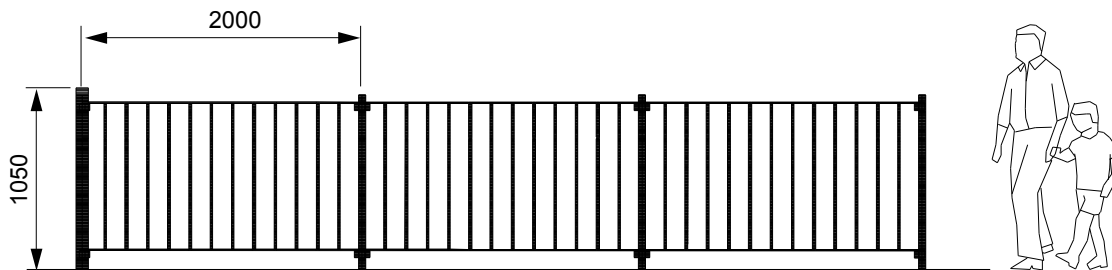

TYPE 1

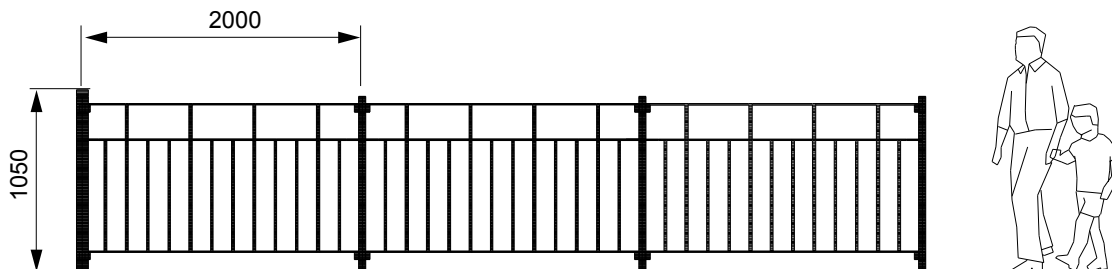

TYPE 5

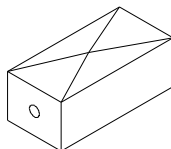

CROSS BREAK

TERMS & CONDITIONS

1. GENERAL

- 1.1 All goods supplied to Purchaser by Supplier under a supply contract are supplied on the following Terms and Conditions.
- 1.2 These Terms and Conditions cannot be varied or modified except by an instrument in writing signed by Supplier.
- 1.3 These Terms and Conditions take precedence over any term and conditions contained in any document of Purchaser or elsewhere and any such terms and conditions have no application to or effect on a supply contract.
- 1.4 Without prejudice to any rights accruing to either party under these Terms and Conditions, either party may terminate this agreement by providing the other party with 30 days written notice.

2. INTERPRETATION

- For the purpose of these Terms and Conditions, unless the context otherwise necessarily requires:
- 2.1 "Purchaser" means any person, firm or corporation including his successors administrators and assigns who or which has requested the supply of goods by Supplier;
- 2.2 "Supplier" means Protective Fencing Pty Limited, ABN 88 000 375 584, 16 Pile Road, Somersby and its successors and assigns;
- 2.3 "additional charges" means charges in addition to the price of goods which may be made by Supplier pursuant to clause 5;
- 2.3A "Consumer Law" means the Australian Consumer Law set out in Schedule 2 of the Competition and Consumer Act 2010 (Cth);
- 2.4 "goods" includes any services associated with the supply and/or installation of goods;
- 2.4A "GST" means the goods and services tax under the A New Tax System (Goods and Services Tax) Act 1999 (Cth);
- 2.5 "job site" means a site other than Supplier's premises at which Purchaser requires delivery of goods under a supply contract;
- 2.6 "related corporation" in relation to Supplier or Purchaser means a corporation which is a related body corporate of Supplier or Purchaser (as the case may require) within the meaning of sections 9 and 50 of the Corporations Act 2001 (Cth);
- 2.7 "scheduling" means the process of determining from the Working Documentation all necessary information about the goods required under a supply contract to enable the goods to be manufactured, labelled and delivered;
- 2.8 "Supplier's premises" means any place from which goods supplied under a supply contract are made available for collection by Purchaser;
- 2.9 "supply contract" means any agreement, however arising, for the supply of goods by Supplier to Purchaser and includes these Terms and Conditions, and all Working Documentation to the supply;
- 2.10 "Variation" means any variation whatsoever to a supply contract including but not limited to amendments to Working Documentation, scheduling and re-scheduling, loading requirements, delivery times and job sites;
- 2.11 "Working Documentation" means architectural drawings, site drawings, structural drawings and construction drawings, specifications and reinforcement schedules or such other similar documents which are provided by or on behalf of Purchaser to Supplier.

2A. CONSUMER LAW

- 2A.1 If the Consumer Law applies to the goods supplied under a supply contract, Supplier's goods come with guarantees that cannot be excluded under the Consumer Law. Purchaser is entitled to a replacement or refund for a major failure and compensation for any other reasonably foreseeable loss or damage. Purchaser is also entitled to have the goods repaired or replaced if the goods fail to be of acceptable quality and the failure does not amount to a major failure.

3. PRICE AND PAYMENT

- 3.1 All goods are sold at Supplier's ruling price at the time of placement of an order for the supply of goods. All applicable taxes, duties or levies (including GST) on the sale of the goods will be added to Purchaser's account.
- 3.2 All quotations for the supply of goods are valid for 30 days from the date shown on the quotation.
- 3.3 Except as provided in clause 3.2, the price of goods is subject to change by Supplier without notice to Purchaser including, but not limited to, change to incorporate any increase in the cost of materials and/or labour and/or freight and cartage.
- 3.4 Subject to the terms of any extended credit agreed in writing by Supplier either generally or in relation to the supply contract, Purchaser must pay Supplier for goods in full no later than upon delivery of the goods the subject of the order.
- 3.5 Notwithstanding clause 3.4, Purchaser must pay Supplier in full for non-standard goods prior to Supplier commencing manufacture of those goods.
- 3.6 Purchaser must pay Supplier on demand interest at the rate of 24% per annum on all overdue amounts owed by Purchaser to Supplier which interest shall be calculated daily. All cost and expenses associated with collecting overdue amounts, including but not limited to legal fees on an indemnity basis and internal costs and expenses of Supplier, are to be paid by Purchaser as a debt due and payable under the supply contract. All Purchaser payments shall be applied first to such costs and expenses, secondly to the accrued interest and thirdly to the overdue amounts.
- 3.7 Purchaser shall not be entitled to retain any money owing to Supplier notwithstanding any default or alleged default by Supplier of the Terms and Conditions including, without limitation, the supply of allegedly faulty or defective goods. Purchaser must make payment to Supplier for goods purchased without set-off.

4. ORDERS

- 4.1 Supplier may in its absolute discretion refuse to supply goods under a supply contract where:
- goods are unavailable for any reason whatsoever;
 - credit limits cannot be agreed upon or have been exceeded; or
 - payment for goods previously supplied to Purchaser or any related corporation of Purchaser or to any other party who is, in the reasonable opinion of Supplier, associated with Purchaser under the same or another supply contract has not been received by Supplier.
- 4.2 Every purchase order by Purchaser for the supply of goods must:
- be in writing;
 - be signed by an authorised representative of Purchaser;
 - identify goods ordered and the total price;
 - specify the required date of delivery;
 - show Supplier's quotation number; and
 - if for non-standard goods, be accompanied by Working Documentation approved and signed by Purchaser showing all required dimensions.
- 4.3 An order will not be deemed by Supplier to have been placed by Purchaser until Supplier is satisfied that Purchaser has provided sufficient details of the goods required to enable Supplier to fill the order.
- 4.4 A variation must be in writing signed by Supplier and Supplier has an automatic extension of the time for delivery of the goods equal to the delay caused by the Variation.
- 4.5 A supply contract cannot be cancelled unless the prior written consent of Supplier is obtained. Where a supply contract is cancelled, Purchaser indemnifies Supplier against any losses, claims, damages, expenses or costs incurred by Supplier as a result of the cancellation, including, but not limited to loss of profit from other orders foregone as a result of the scheduling of the order which is subsequently cancelled.
- 4.6 Purchaser must deliver all Working Documentation without charge to Supplier and Supplier has no responsibility for the correctness of Working Documentation and is not liable to Purchaser if the

Working Documentation is not accurate. The Purchaser is responsible for ensuring that the Working Documentation is correct and accurate.

- 4.7 Lead times for all products may vary from time to time without notice. Supplier is not liable for any losses, claims, damages, expenses or costs experienced by Purchaser arising as a result of a variation in lead times.

5. ADDITIONAL CHARGES

- In addition to payment of the price of goods, Purchaser is responsible for:
- taxes (other than income tax), stamp duty or other statutory charges of levies whether State or Federal payable in relation to the supply of goods; in particular G.S.T.;
 - the cost of delivery of goods to a job site or to Purchaser's premises;
 - storage charges where goods are not collected immediately upon delivery;
 - demurrage costs or charges incurred by Supplier for attendance at a job site after the first 15 minutes, such charges to be calculated at reasonable industry rates;
 - legal costs and disbursements on an indemnity basis incurred by Supplier in relation to a breach of a supply contract by Purchaser including, but not limited to a failure by Purchaser to pay for the goods on time;
 - all costs, charges, expenses or any other outgoings incurred by Supplier with respect to any Variation by Purchaser;
 - all costs or charges incurred by Supplier with respect to the recovery or return of goods from Purchaser whether or not such recovery or return of goods occurs in relation to any breach of a supply contract;
 - any costs or charges incurred by Supplier in relation to the installation of goods; and
 - the cost of any testing or inspection of goods, or products or materials used in relation to the manufacture of goods, which are required by Purchaser;
 - all costs or charges incurred by Supplier for Purchaser's payment to Supplier using bank or credit card.

6. DELIVERY

- 6.1 Purchaser must give 2 business days' notice of the date for delivery of goods by Supplier and unless otherwise agreed in writing, delivery shall be at Supplier's premises during normal business hours and occurs on the earlier of either actual collection of goods or the provision of notice of delivery to Purchaser.
- 6.2 Where delivery of goods is agreed to be made at a job site:
- Purchaser shall give notice of the job site to Supplier 2 business days prior to Supplier's intended delivery date.
 - Delivery shall be as close to job site as in the opinion of Supplier or its agents physical conditions and safety allow and delivery occurs when goods arrive at that place;
 - Unloading of goods at job site is the responsibility of Purchaser at Purchaser's cost but Supplier reserves the right to unload goods in the absence of Purchaser and Purchaser shall indemnify Supplier against any resulting losses, claims, damages, expenses or costs; and
 - Supplier is not liable for any damage to property or personal injury occurring on the job site and Purchaser shall indemnify Supplier against any charge or cost of whatsoever nature and kind incurred in relation to entering the job site.
- 6.3 Where a delivery of goods cannot be effected a delivery and return fee based on reasonable industry rates and an administration or storage fee will be charged to Purchaser at rates selected by Supplier.
- 6.4 A quantity, description, date, and place of delivery of goods as indicated on Supplier's invoice or delivery docket or copies thereof ("the consignment note") is conclusive evidence of quantity, description, date, and place of delivery of the goods. Purchaser warrants that the person who signs the delivery notice is authorised to receive the goods on behalf of Purchaser.
- 6.5 While Supplier will endeavour to meet delivery dates, any delay of delivery for any reason whatsoever will not entitle Purchaser to claim for any consequential loss or damage or to cancel, rescind or terminate the supply contract.

7. ACCEPTANCE OF GOODS

- 7.1 Subject to the Consumer Law, if Purchaser fails to advise Supplier in writing of any fault in goods or failure of goods to accord with a supply contract within 48 hours of delivery:
- Purchaser is deemed to have accepted the goods under the supply contract and to have accepted that the goods are not faulty and accord with the supply contract; and
 - Purchaser shall keep Supplier indemnified from any claims, damages, expenses or costs resulting from or arising out of the use of the goods by Purchaser whether or not such goods are damaged or defective.
- 7.2 Non-standard goods which have been manufactured to Purchaser specifications under a supply contract will not be accepted for credit and Purchaser must pay a deposit of 20% of the value of the non-standard goods and then the balance before delivery of the non-standards goods.
- 7.3 Subject to paragraph 7.2 goods may be accepted for credit at the sole discretion of Supplier. To the extent permitted by law Supplier reserves the right to charge an administration and handling fee calculated in accordance with the adopted practice of a minimum charge of \$15.00 up to a maximum of 15% of the full retail value of the goods. Freight incurred on goods returned will be to Purchaser's account.
- 7.4 Goods are not deemed damaged or defective by reason only of the presence of rust, mill scale or rolling seams except as provided in AS3600.
- 7.5 Purchaser acknowledges that there may be minor variations in masses, dimensions and colours and Supplier is not liable for any losses, claims, damages, expenses or costs incurred or suffered by Purchaser as a result of such variations.

8. AGENCY AND ASSIGNMENT

- 8.1 Purchaser agrees that Supplier may at any time appoint or engage an agent to perform an obligation of Supplier arising out of or pursuant to a supply contract.
- 8.2 Supplier has the right to assign and transfer to any person or company all or any of its title, estate, interest, benefit, rights, duties and obligations arising in, under or from any supply contract provided that the assignee agrees to assume any duties and obligations of Supplier so assigned and transferred. The sale of all or substantially all of the issued shares in the share capital of Supplier or of a related corporation of Supplier is not an assignment of any supply contract and such sale shall not effect, modify, abrogate or terminate any supply contract or the validity or enforceability thereof.
- 8.3 Purchaser may not assign, or purport to assign, any of its obligations or rights under a supply contract without the prior written consent of Supplier.

9. RISK AND PROPERTY

- 9.1 Title to any goods delivered to Purchaser will not pass to Purchaser until Purchaser has paid all amounts that it owes to Supplier in full.
- 9.2 Property in goods delivered under a supply contract does not pass to Purchaser until all moneys due and payable to Supplier by Purchaser have been fully paid and, in the case of goods which are installed by Supplier, until Purchaser has inspected the completed installation and given to Supplier written acceptance that the goods and installation are satisfactory and accord with the supply contract.
- 9.3 Where goods are delivered by Supplier to Purchaser under a supply contract without payment in full of all moneys payable under the supply contract, Purchaser:
- holds the goods on trust for Supplier until all moneys due and payable by Purchaser has been fully paid;
 - irrevocably appoints Supplier its attorney to do all acts and things necessary to ensure the retention of title to goods; and

TERMS & CONDITIONS

c) must separate and identify as belonging to Supplier goods delivered by Supplier from other goods which are held by Purchaser in storage for resale, distribution, incorporation or mixing of goods to make new goods.

9.4 Where Purchaser makes a new object from the goods, whether finished or not, or Purchaser mixes the goods with other goods or the goods become part of other goods ("new goods"), Purchaser agrees with Supplier:

- that the ownership of the new goods immediately passes to Supplier;
- that until payment of all sums owing to Supplier whether under the supply contract or any other contract Purchaser will hold the new goods on trust for Supplier; and
- if required by Supplier, to store the new goods in a manner that clearly shows the ownership of Supplier.

9.5 For the avoidance of doubt, the ownership of the new goods passes to Supplier at the beginning of the operation or event by which the goods are converted into, are mixed with or become part of other goods.

9.6 Notwithstanding sub-clause 9.3 Purchaser may transfer, sell or dispose of goods, including new goods, to a third party in the ordinary course of business provided that:

- where Purchaser is paid by a third party in respect of goods including new goods, Purchaser shall hold the whole of the proceeds of sale less GST on trust for Supplier until all amounts owned by Purchaser to Supplier have been paid; or
- where Purchaser is not paid by a third party, Purchaser agrees to assign all Purchaser's rights against such third party to Supplier upon Supplier giving Purchaser notice in writing to that effect and for the purpose of giving effect to such assignment Purchaser irrevocably appoints Supplier its attorney.

9.7 If Purchaser does not pay Supplier the amount Purchaser owes Supplier for the goods when due, Supplier may re-take possession of the goods. Supplier may enter any land or premises for the purpose of re-taking possession. If Supplier retakes possession of any goods, it may deal with them as it thinks fit.

9.8 Purchaser will be deemed to have accepted the terms of this clause 9 by placing an order for any goods, taking or accepting delivery of any goods, or using any goods whether or not Purchaser acknowledges or signs the terms of trade.

9A. PERSONAL PROPERTY SECURITIES ACT

9A.1 In this clause 9A:

- PPSA means the Personal Property Securities Act 2009 (Cth);
- words and phrases that have defined meanings in the PPSA have the same meaning as in the PPSA unless the context indicates otherwise.

9A.2 If any goods become an accession to or other property or become part of a product or mass, then:

- Supplier's security interest continues in the other property, product or mass; and
- references to the goods include the other property, product or mass.

9A.3 Purchaser consents to the Seller perfecting any security interest that it considers these Terms and Conditions provides for by registration under the PPSA. Purchaser agrees to do anything Supplier reasonably asks to ensure that the security interest:

- is enforceable, perfected and otherwise effective; and
- has priority over all other security interests.

9A.4 To the extent the law permits, Purchaser waives its right to receive any notice (including notice of a verification statement) that is required by the PPSA. However, this does not prevent Supplier from giving a notice under the PPSA.

9A.5 Purchaser agrees not to exercise its rights to make any request of Supplier under section 275 of the PPSA. However, this does not limit Purchaser's rights to request information other than under section 275.

9A.6 To the extent the law permits, Supplier need not comply with, and Purchaser may not exercise rights under, any provisions of Chapter 4 of the PPSA that may be contracted out of.

9A.7 If Supplier exercises a right, power or remedy in connection with this document or a security interest that it provides for, that exercise is taken not to be an exercise of a right, power or remedy under the PPSA unless Supplier states otherwise at the time of exercise. However, this clause does not apply to a right, power or remedy which can only be exercised under the PPSA.

9A.8 Neither Supplier or Purchaser will disclose any information of the kind mentioned in section 275(1) of the PPSA, except where disclosure is required by section 275(7). Purchaser will not authorise the disclosure of any information under that section or waive any duty of confidence that would otherwise permit non-disclosure under that section. This subclause does not apply if disclosure is required by law, to a related body corporate or to the party's professional advisers.

9A.9 Purchaser must notify Supplier at least 14 days before it does any of the following:

- changes its name;
- changes its place of registration or incorporation;
- changes or applies for an ACN, ABN, ARBN or ARSN under which an interest in any of the goods is or will be held.

10. WARRANTIES AND EXCLUSIONS

10.1 All express or implied terms, conditions, warranties, statements, assurances and representations in relation to any goods ordered from Supplier are hereby excluded from a supply contract save for:

- these Terms and Conditions;
- the conditions and warranties necessarily implied under the Consumer Law and any statutory modification or re-enactment thereof; and
- any other terms and conditions to which Supplier agrees in writing to be bound.

10.2 Any liability of Supplier which is not excluded by clause 10.1 is limited to the extent permitted by law to such one or more of the following as determined by Supplier in its absolute discretion:

- with respect to the supply of goods:
 - the replacement of the goods or the supply of equivalent goods;
 - the repair of the goods; or
 - the payment of the cost of replacing the goods or of
- acquiring equivalent goods; or
- the payment of the cost of having the goods repaired;
- with respect to the supply of services:
 - the re-supply of the services; or
 - the payment of the cost of having the services re-supplied.

10.3 Subject to the Consumer Law, Purchaser acknowledges that except for these Terms and Conditions, Supplier does not give or make any warranty assurance, promise or representation regarding the quality, fitness for use, suitability or merchantability of goods for any purpose whatsoever, and that in entering into the supply contract Purchaser has relied entirely on Purchaser's own knowledge, skill and judgement.

10.4 Subject to the Consumer Law, Purchaser agrees that:

- any advice given by Supplier in relation to the use or installation of goods;
- any testing or inspection of goods at Purchaser's request;
- any advice given by Supplier in connection with the use or installation of goods in accordance with specifications or design information provided by Purchaser to Supplier; and
- any advice given by Supplier in relation to the supply use or installation of goods where no specification or design information is provided by Purchaser; is given or undertaken on the basis that Supplier assumes no obligation or liability in respect thereof. Purchaser further agrees that where specifications or design information is provided by Purchaser, Supplier assumes no obligation or liability in respect of the supply of goods in accordance with the specifications or design information provided.

10.5 A supply contract is not a sale by reference to sample unless expressly so stated.

10.6 To the extent permitted by law, Supplier is not liable for losses, claims, damages, expenses or costs of any kind arising out of the loading or securing of loads of goods whether arising in negligence or otherwise.

10.7 Purchaser indemnifies Supplier in respect of all claims, damages, expenses or costs arising from any breach by Supplier of a third party's rights in relation to any Working Documentation.

11. DEFAULT BY PURCHASER

11.1 Each of the following occurrences constitutes an event of default:

- Purchaser breaches or is alleged to have breached a supply contract for any reason (including, but not limited to, defaulting on any payment due under a supply contract);
- Purchaser:

- being a natural person, commits an act of bankruptcy; or
- being a corporation, is subject to:

A. a petition being presented, an order being made or a meeting being called to consider a resolution for Purchaser to be wound up, deregistered or dissolved;

B. a receiver, receiver and manager or an administrator under Part 5.3A of the Corporations Act 2001 being appointed to all or any part of Purchaser's property and undertaking;

C. the entering of a scheme of arrangement (other than for the purpose of restructuring); or

D. any assignment for the benefit of creditors; or

c) Purchaser ceases or threatens to cease conduct of its business in the normal manner.

11.2 Where an event of default occurs, except where payment in full has been received by Supplier, Supplier may:

- refuse to deliver goods;
- repossess and re-sell any goods delivered to Purchaser, the payment for which has not been received; or
- retain (where applicable) all moneys paid on account of goods or otherwise.

11.3 In addition to any action permitted to be taken by Supplier under 11.2 above, upon the occurrence of an event of default, Supplier may terminate all supply contracts and credit arrangements with Purchaser. No compensation will be paid to Purchaser and Supplier is not liable for costs, losses or claims as a result of the termination of supply contracts or credit arrangements.

11.4 For the purposes of 11.2(b) above, Purchaser grants an irrevocable licence to Supplier or its agent to enter Purchaser's premises or job site in order to recover possession of the goods in question. Purchaser indemnifies Supplier in respect of any damage to property or personal injury which occurs as a result of Supplier entering the premises or job site of Purchaser.

11.5 Clause 11 does not limit the generality of any other clause of this agreement.

12. GENERAL

12.1 Any document addressed to Purchaser shall be deemed to be sufficiently served if:

- posted by ordinary pre-paid post addressed to Purchaser at Purchaser's last known address and shall be deemed to have been received by Purchaser on the second business day following the date on which it was posted; or
- transmitted by facsimile transmission or electronic mail during normal business hours on a business day and shall be deemed to have been given on the business day which next follows the day of transmission.

12.2 A term or condition of this agreement (whether a whole clause or part of a clause) which is invalid, unlawful, void or unenforceable is capable of severance without affecting any other term or condition.

12.3 A certificate signed by the relevant branch manager for the time being of Supplier stating any matter or thing arising directly or indirectly out of a supply contract is prima facie evidence of the matters contained in such certificate and Purchaser agrees not to object to the admissibility of such a certificate in any legal proceedings.

12.4 No waiver by Supplier of any breach of the Terms and Conditions will be construed as a waiver of any subsequent breach of the same or any other Term or Condition.

13. FORCE MAJEURE

13.1 Supplier will not be liable for any loss, damage or expense suffered by Purchaser caused by Supplier's failure to complete the order or to deliver products at all, or at the estimated time as a result of causes beyond Supplier's reasonable control, including but not limited to any breach or default of the order by Purchaser, compliance with any laws, regulations, orders, acts, instructions or priority requests of governments, acts of God, fires, floods, weather, strikes, lockouts, factory shutdown or embargoes, wars, riots, delay or shortage in transportation or inability to obtain labour, manufacturing materials or other materials from Supplier's normal suppliers.

13.2 Any delay resulting from such cause set out in clause 13.1 will, at Supplier's absolute discretion:

- immediately extend the estimated date for performance by Supplier of any obligations by the period of the delay; or
- entitle Supplier to terminate the supply contract by notice to the Purchaser in which no compensation is payable to Purchaser and Supplier is not liable for any costs, losses or claims as a result of termination of the supply contract.

14. GST

14.1 Words defined in A New Tax System (Goods and Services Tax) Act 1999 have the same meanings when used in this clause.

14.2 This clause applies if, during the continuance of a supply agreement, any person is or may become liable to pay GST for any supply under a supply agreement (in this clause called "Taxable Supply") for which the amount payable has not been calculated on a GST inclusive basis.

14.3 In addition to any payments to a party (in this clause called the "Receiving Party") by another party (in this clause called the "Paying Party") under the supply contract (in this clause called the "GST Exclusive Consideration") the Paying Party must, upon receipt of an invoice from the Receiving Party, pay GST on the Taxable Supply to the Receiving Party of an amount equal to the GST Exclusive Consideration multiplied by the GST Rate.

14.4 The Paying Party must pay GST at the same time and on the same basis as the GST Exclusive Consideration under the supply agreement is payable.

14.5 The Receiving Party must issue an invoice or invoices (containing such particulars as are required by the GST Law in order that the Paying Party may obtain an input tax credit for the amount of GST payable on the Taxable Supply) to the Paying Party for the amount of GST for the Taxable Supply.

14.6 If the Receiving Party or the Paying Party determines, on reasonable grounds, that the amount of GST for any Taxable Supply under the agreement differs for any reason from the amount of GST payable by the Paying Party under this clause, the Receiving Party and the Paying Party must adjust the amount of GST paid or payable by the Paying Party for the difference and, if the Paying Party has overpaid, the Receiving Party must refund the overpaid amount to the Paying Party.

14.7 Where an Adjustment Event in relation to any Taxable Supply has occurred the Receiving Party must provide an Adjustment Note to the Paying Party within five business days.

15. WHOLE AGREEMENT

15.1 These conditions of sale and any variation expressed in writing by Supplier to Purchaser represent the whole agreement between the parties relating to the subject matter of these terms and supersedes all oral and written negotiations and communications by and on behalf of either of the parties.

15.2 Purchaser has not, in entering into a supply contract, relied on any warranty, representation or statement, whether oral or written, made or published by Supplier or any of its servants or agents relating to or in connection with the subject matter of a supply contract.

WIRE MESH
WIRE FORMING
WIRE BENDING
WELDMESH FENCING
TIE WIRE
TENNIS COURTS
TEE POSTS
STEEL FABRICATION
STAINLESS STEEL MESH
SAFETY MESH
RURAL MESH
ROOF SAFETY MESH
ROLL TOP MESH FENCING
RMS FENCING
RAZOR WIRE
CHAINWIRE PVC COATED
CHAINWIRE FUSE BONDED PVC
PROMAX PALISADE
PROMAX 358 SECURITY MESH
POWDER COATING
POSTS
POOL FENCING
PIPE
TUBULAR FENCING
GOLF SCREEN MESH
GATES
FITTINGS
EDGE PROTECTION PANELS
CUT & STRAIGHTENED WIRE
CRICKET NETS
CONSTRUCTION FENCING
CLIPS
CHAINWIRE
BUSHFIRE MESH
BARBED WIRE

PROTECTIVE GROUP OF COMPANIES

Protective Group is a leading Australian manufacturer and supplier to the fencing and wire mesh markets throughout Australia and the Asia Pacific region.

The Protective group of companies manufacture and distribute a wide range of steel, wire, tubular fencing and associated products from its manufacturing and distribution centres in Somersby New South Wales, Dandenong Victoria and Yatala Queensland.

FENCING

Protective Fencing Pty Ltd offer a wide range of fencing products for all situations, from domestic to our unique high security systems. Our products are used widely through out Australia and the Asia Pacific region and comply with all relevant Australian standards.

WIRE MESH INDUSTRIES

Protective wire Mesh Industries Pty Ltd are a leading Australian manufacturer of specialised welded wire mesh.

We have significant machine capabilities to meet the highly specified requirements of the mining, safety, fabrication and fencing markets.

With several generations of experience in the wire and mesh industry, our staff are highly qualified to recommend the best solutions to your welded wire mesh requirements.

Specialty mesh capabilities include custom sheets for fabrication of pallet cages, trailer cages, beds, guards, screens and cable tray mesh.

POWDER COATING

Protective Powder Coating Pty Ltd is a fully integrated business of Protective Group focusing on both in house powder coating for Protective Fencing and Protective Wire Mesh Industries as well as offering powder coating services to an extensive range of commercial customers.

Our dual batch and in-line systems provide the capacity to coat a wide range of sizes and quantities.



**SOMERSBY
NSW**

**DANDENONG
VICTORIA**

**YATALA
QUEENSLAND**

www.profence.com.au